

Power cable
diameter and section
depends on rated current
U : Phase 1
V : Phase 2
W : Phase 3
Green/Yellow : Ground

Resolver + thermal sensors cable
Sinus + (S2) : Green
Sinus - (S4) : Yellow
Cosinus + (S1) : White
Cosinus - (S3) : Brown
Input carrier + (R1) : Red
Input carrier - (R3) : Blue
PTC : Grey
KTY84 : Black
KTY84 : Violet

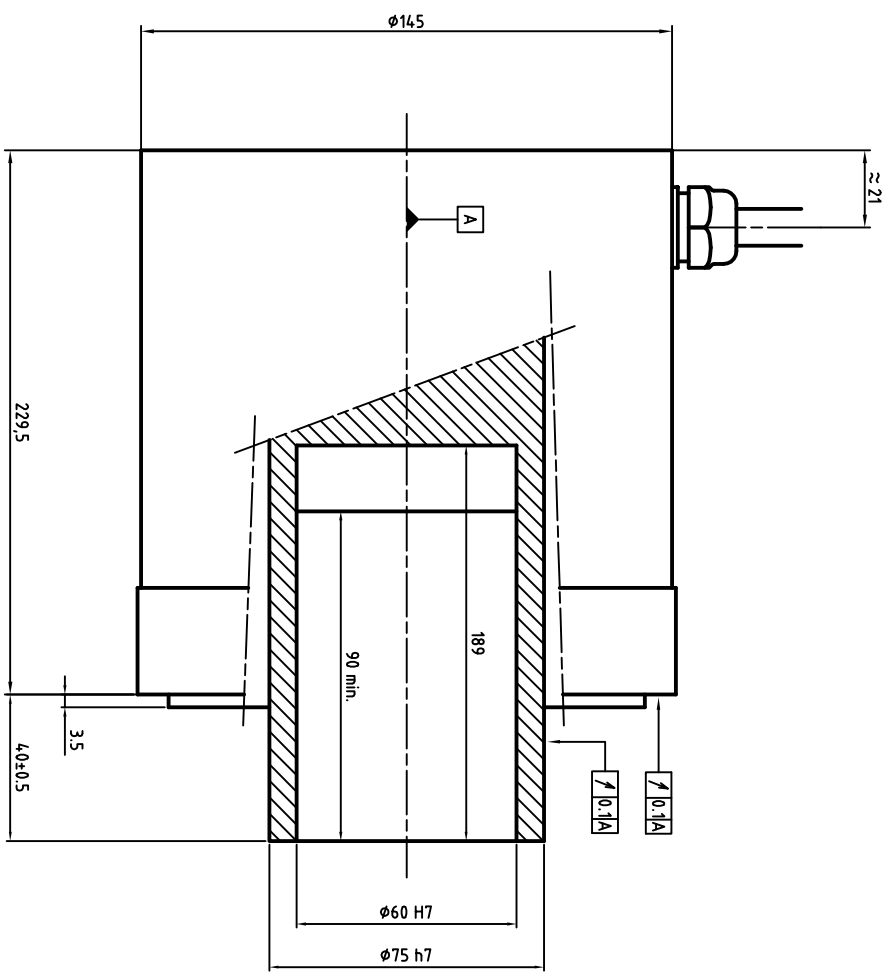

ALXION

AUTOMATIQUE & PRODUCTIQUE
Parc Technologique des Fossés Jean
92712 COLONBES Cedex
Tél: 0141306304 - Fax: 0141306136

145ST4M266BXXXX