

Power cable diameter and section depends on rated current
 U : Phase 1
 V : Phase 2
 W : Phase 3
 Green/Yellow : Ground

Resolver + thermal sensors cable
 Sinus + (S2) : Green
 Sinus - (S4) : Yellow
 Cosinus + (S1) : White
 Cosinus - (S3) : Brown
 Input carrier + (R1) : Red
 Input carrier - (R3) : Blue
 PTC : Grey
 KTY84 : Pink
 KTY84 : Black
 KTY84 : Violet

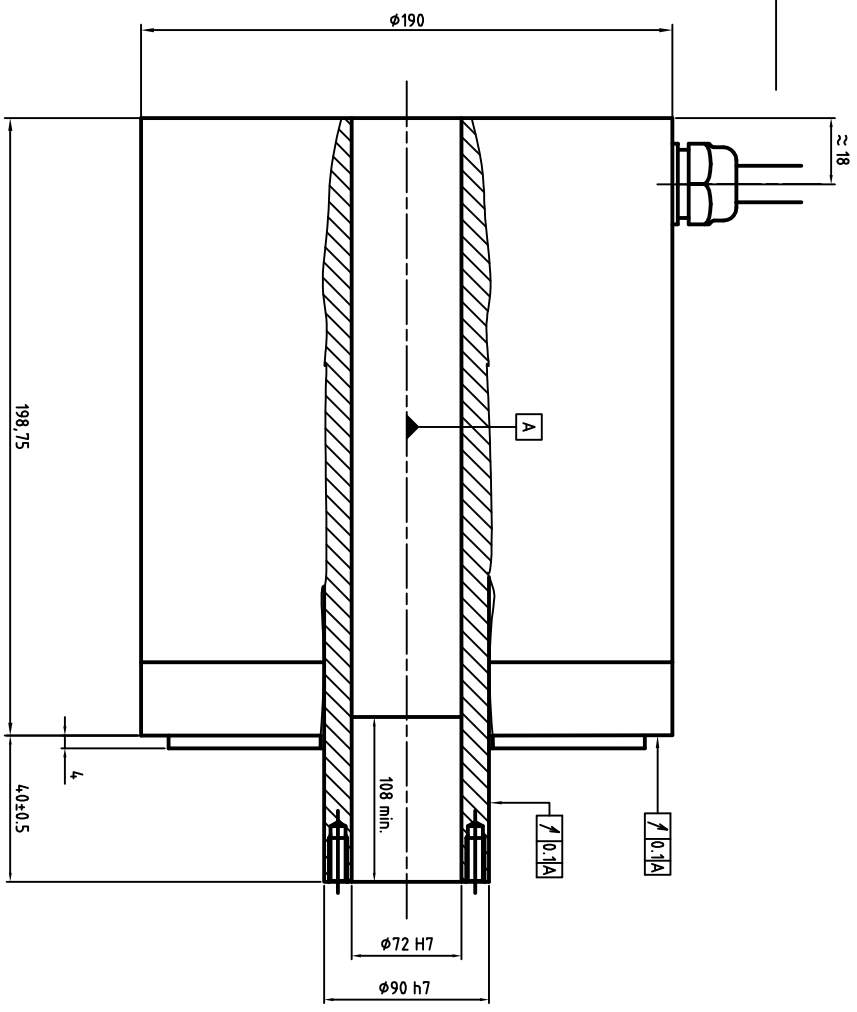

ALXION

AUTOMATIQUE & PRODUCTIQUE
 Parc Technologique des Fossés Jean
 92712 COLOMBES Cedex
 Tél: 0141306304 - Fax: 0141306136

190ST1M21BXXXX