

Power cable diameter and section depends on rated current  
 U : Phase 1  
 V : Phase 2  
 W : Phase 3  
 Green/Yellow : Ground

Resolver + thermal sensors cable  
 Sinus + (S2) : Green  
 Sinus - (S4) : Yellow  
 Cosinus + (S1) : White  
 Cosinus - (S3) : Brown  
 Input carrier + (R1) : Red  
 Input carrier - (R3) : Blue  
 PTC : Grey  
 PTC : Pink  
 KTY84 : Black  
 KTY84 : Violet

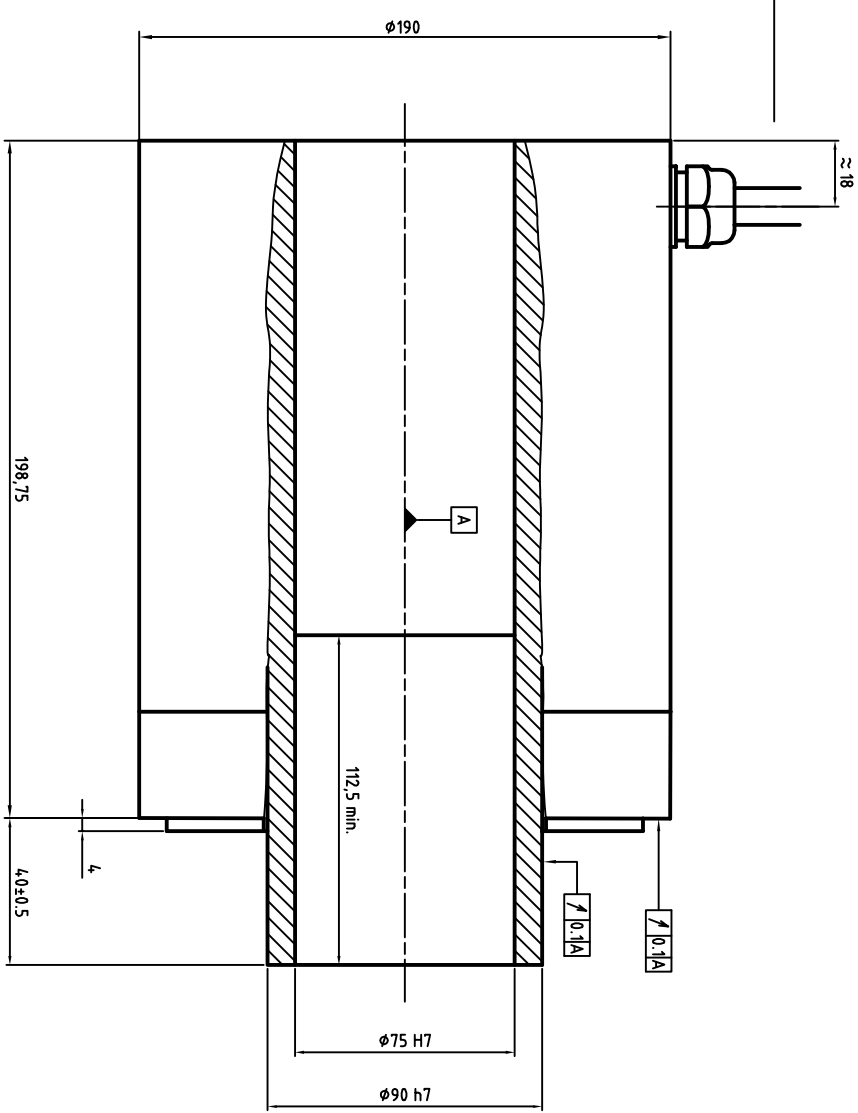

**ALXION**

AUTOMATIQUE & PRODUCTIQUE  
 Parc Technologique des Fossés Jean  
 92712 COLOMBES Cedex  
 Tél: 0141306304 - Fax: 0141306136

190S T1M271BXXXX