

Vue sur connecteur
Detail on connector

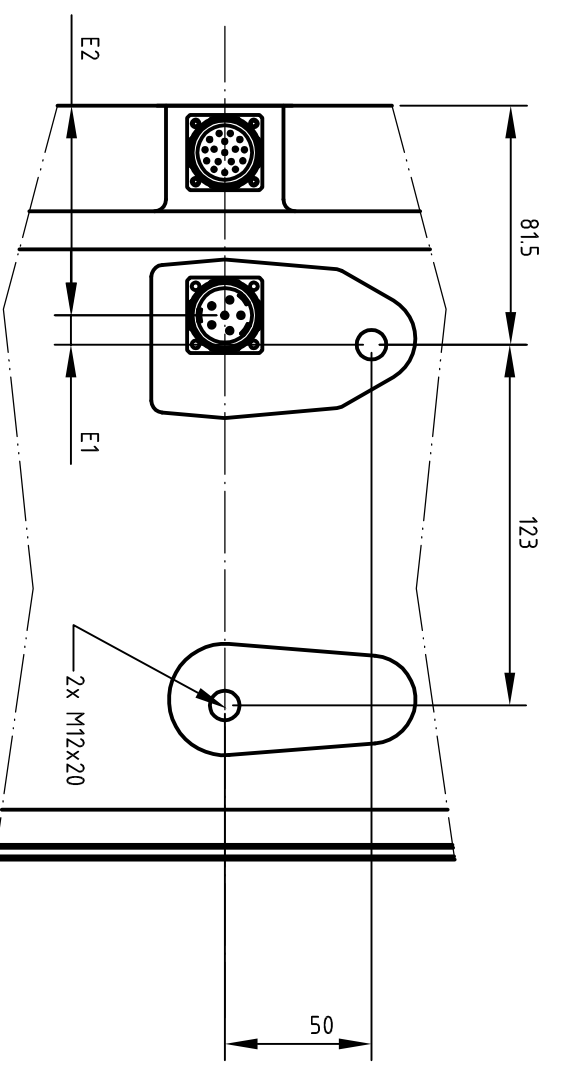
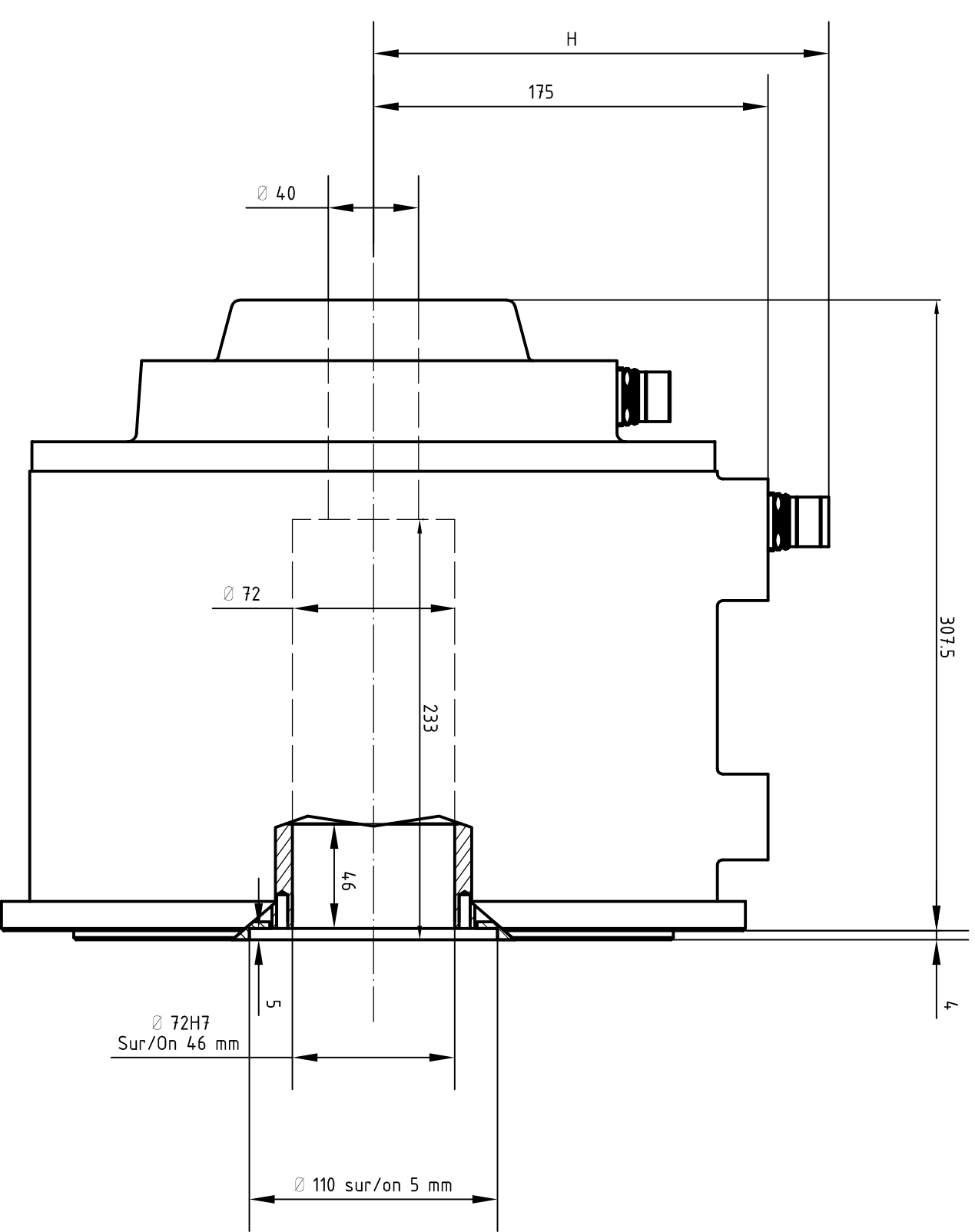

Courant à couple permanent Current at continuous torque	H	E1	E2
< 25 A	202	10	55.5
> 25 A	217	2	63.5

ALXION

AUTOMATIQUE & PRODUCTION
Parc Technologique des Fosses Jean
92712 COLOMBEES Cedex
Tél: 0141306304 - Fax: 0141306136

300ST5M18[2-7]XXXXCX