

Cable	Ø	R min.
2x2x0.25	7	84
4x1.5	10.2	120
4x2.5	11.4	135
4x4	13.1	155
4x6	15.9	190
4x10	18.8	225

Cable output length 2m:

Power :
One shielded class 6
cable coded

1,2,3 green/yellow

Thermal sensors :

One shielded class 6

cable (2x2x0.25mm²)

Brown-White : PTC

Green-Yellow : KTY84

Minimum bending radius

(except for the first 50mm) :

See table

ZONE FREE OF ANY PART
(cable passing)
NO STRESS, NO BENDING, IN THIS AREA

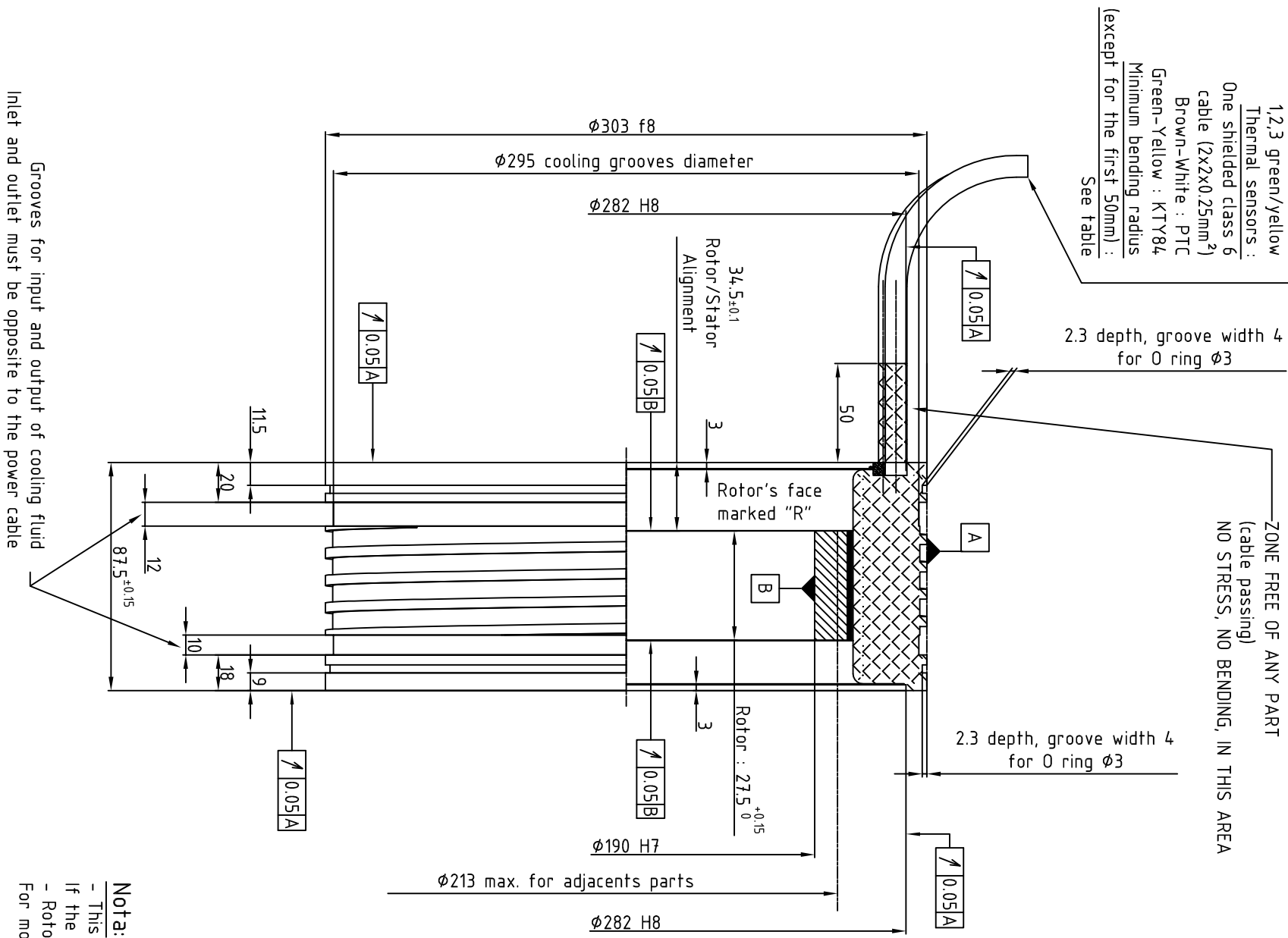

2 series of 12 equidistant holes M5x12
One serie on each rotor face
Angularly aligned series

2 series of 12 equidistant holes M5x12
One serie on each stator face
Angularly aligned series

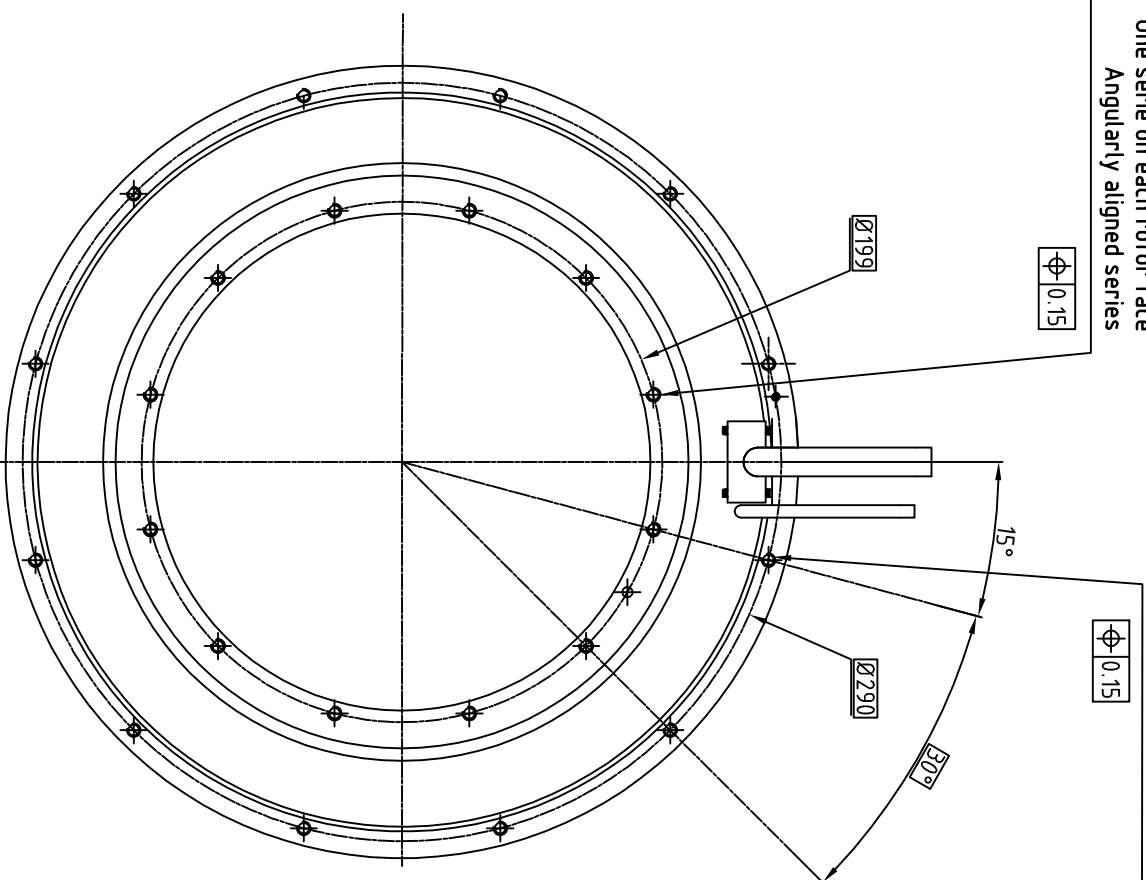

Nota:

- This drawing is valid only for motors with nominal current lower than 72 Amps.
- If the nominal current is greater than 72 Amps, please contact us.
- Rotor is not fitted in the stator
- For more information about mounting see document 300STK0-WA002

CAUTION: For a better safety, it is recommended that the cooling fluid inlet would be made through the hose located on the side opposed to the cabling, while the cooling fluid outlet will be made by the one located on the cable side.

ALXION
AUTOMATIQUE & PRODUCTION
Parc Technologique des Fossés Jean
92712 COLOMBES Cedex
Tél: 014.1306304 - Fax: 014.1306136

300STK1M2XXXXXX