

# **ALXION** *SERVOMOTORS* *for Direct Drive*



**ALXION**  
AUTOMATIQUE  
& PRODUCTIQUE

# ALXION

Automatique & Productique

## DIRECT DRIVE CATALOGUE

Designed with the aim of addressing new industrial needs, **ALXION** has created ST low inertia motors range for **DIRECT DRIVE** allowing acceleration up to 20 000 rad/s<sup>2</sup>. ST range is proposed in three diameters, 145, 190 and 300 mm with a variety of hollow shafts up to internal diameter 75 mm, blind shafts or solid shafts.

Rated torques cover a wide range between 14.6 Nm and 261 Nm in natural convection, and the peak torque covers from 55 Nm up to 1161 Nm. The motors can reach a rated speed from 200 rpm up to 1500 rpm according to the windings and allow a high regularity of rotation at low speed.

Those motors present an outstanding compacity with a continuous torque-to-weight up to 3.7 Nm/Kg and a peak torque-to-weight up to 18 Nm/Kg.

Their design allows the integration of a high variety of resolvers or encoders.

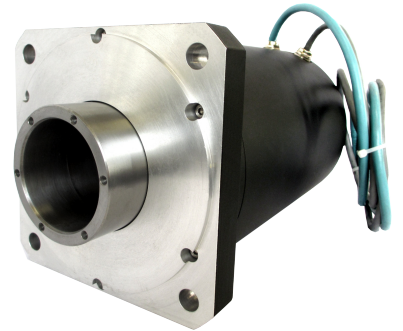

Based on the need for a maximal accuracy of the servomechanism, the resolvers developed by **ALXION** are adapted to the Motors for Direct Drive of its ST Range and can be used advantageously in axis using STK motors. They represent a further necessary step towards the exploitation of the direct drive technology.

Thanks to its long experience in Direct Driving, **ALXION** has developed its products portfolio with a range of **DIRECT DRIVE** frameless motors.

Complementary to its ST range, those motors in kits (armature + rotor) are designed to be integrated inside machines which require very high hollow shaft diameter as well as accuracy and speed regularity.

STK frameless motors range presents outstanding rated torques from 15Nm up to 2708 Nm in natural convection and can reach 6100 Nm by using fluid cooling.

The peak torque can be 4 times higher than the rated one (up to 11310Nm).

The high hollow shaft diameter allows internal clearance between 56 mm and 630 mm.



**ALXION** has made a complete technical documentation and ensures an appropriate technical support for allowing a close collaboration with the users starting from the machine design.

Those motors can be controlled with all types of drives dedicated to Brushless sinusoidal control servo system.

Those **ALXION DIRECT DRIVE** ranges have been designed and industrialised with the aim to ensure excellent dynamics and accuracy and highest reliability as well as acceptable costs for the users.

**DIRECT DRIVE IS MORE THAN AN IDEA**

# INDEX

## ST Motors

Presentation.....	3
145ST	
Characteristics.....	5
Dimensions.....	8
Codification.....	9
190ST	
Characteristics.....	11
Dimensions.....	14
Codification.....	15
300ST	
Characteristics.....	17
Dimensions.....	20
Codification.....	21
Option & Description of differents feedback position.....	22
Cabling.....	23

RESOLVER ALXION.....	24
----------------------	----

## STK Motors

Presentation.....	27
145STK	
Dimensions.....	30
Characteristics.....	31
Curves torque vs speed.....	32
190STK	
Dimensions.....	34
Characteristics.....	35
Curves torque vs speed.....	36
300STK	
Dimensions.....	38
Characteristics.....	39
Curves torque vs speed.....	40
400STK	
Dimensions.....	42
Characteristics.....	43
Curves torque vs speed.....	44
500STK	
Dimensions.....	46
Characteristics.....	47
Curves torque vs speed.....	48
800STK	
Dimensions.....	50
Characteristics.....	51
Curves torque vs speed.....	52
STK Motors codification.....	54

# ST MOTORS RANGE :

## HIGH TORQUE-TO-WEIGHT PM MOTOR WITH LOW INERTIA FOR DIRECT DRIVE



Designed with the aim of addressing new industrial needs, **ALXION** has created **ST** low inertia motors range for **DIRECT DRIVE** allowing acceleration up to 20 000 rad/s<sup>2</sup>. Proposed in three diameters, 145, 190 and 300 mm with a large variety of position feedback: resolvers, encoders and a variety of shafts: hollow, blind or solid shaft. Rated torques cover a wide range between 14.6 Nm and 235 N.m, in natural convection, and the peak torque covers from 55 Nm to 1161 Nm. The motors can reach a rated speed up to 1500 rpm. These motors present an outstanding compacity with a continuous torque-to-weight up to 3.7 Nm/Kg and a peak torque-to-weight up to 18 Nm/Kg. Two windings are proposed as a standard: 500 and 1500 rpm for 145ST, 500 and 1000 rpm for 190ST and 200 and 800 rpm for 300ST. But the winding can easily be adapted to match your optimum drive rating.

### MAIN CHARACTERISTICS

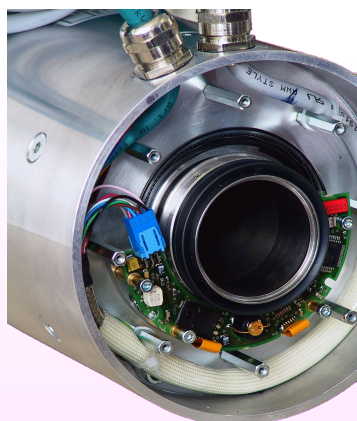

Integration of a SCS KIT 101 encoder inside a hollow shaft 145ST

	145 ST	190 ST	300 ST
Windings (standard)	500 and 1500 rpm	500 and 1000 rpm	200 and 800 rpm
Continuous torque ( N.m )	Up to 47.4	Up to 111	Up to 261
Peak torque ( N.m )	Up to 220	Up to 476	Up to 1161
Hollow shaft diameter ( mm )	Up to Ø 60	Up to Ø 75	Up to Ø 72
Motor technology	HP or SP		X
Position feedback	.Resolver accuracy ±1 arc min .SinCos encoders : incremental or with commutation track. .ENDAT absolute encoders .HIPERFACE® encoders .Resolver accuracy ±10 arc min		
Power and signal connections :	Class 6 cables 2 meters length		Circular connectors
Protection degree	Ip 54		
Humidity	< 85% (not condensing)		

Motor technology :

SP: Standard precision technology ; cogging ≤2% of rated torque

HP: High precision technology ; cogging <1% of rated torque

X : High precision technology ; cogging <2% of rated torque

### ASSETS:

- High dynamics
- No gear
- No backlash
- High accuracy servo
- Elimination of maintenance
- Simplification of servomechanism
- Noise reduction
- Machine optimisation and simplification

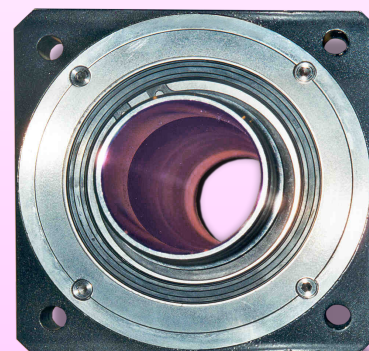

# 14ST MOTORS

Continuous torque : from 8 N.m up to 47.4 N.m

Peak torque : from 27.5 N.m up to 220 N.m

Hollow shaft : up to 60 mm

Rated speed : from 500 rpm up to 1500 rpm

# TECHNICAL CHARACTERISTICS 145ST

## Windings for 400V / 460Vac drives (See Application note)

			145ST1M		145ST2M		145ST3M		145ST4M		145ST6M		145ST8M	
Rated speed	rpm		500	1500	500	1500	500	1500	500	1500	500	1500	500	1500
Continuous torque at stall (4)	N.m		8		14.6		20.5		26.4		37.3		47.4	
Current at continuous torque (1)	A		1.6	2.9	2.3	5.2	2.9	6.7	3.7	9.2	5	12.7	6.4	15.7
Peak torque (2)(3)	N.m		27.5		55		83		110		165		220	
Current at peak torque (2)	A		6.9	11.1	10.2	23.1	14.9	34.2	17.8	45.5	27.3	68.3	35.6	91.1
Rated power (1)	W		390	866	710	1850	992	2504	1260	3080	1770	3830	2230	4580
Inertia without position feedback (8)	Solid shaft	10 <sup>-3</sup> kg.m <sup>2</sup>	0.75		1.16		1.62		1.98		2.8		3.62	
	Hollow shaft Ø30		0.78		1.19		1.65		2.02		2.84		3.66	
	Blind shaft Ø56		1.99		2.46		2.94		3.41		4.37		5.32	
	Blind shaft Ø60		1.69		2.1		2.52		2.93		3.75		4.57	
Inertia with resolver	Hollow shaft Ø56	10 <sup>-3</sup> kg.m <sup>2</sup>	4.46		4.94		5.42		5.9		6.85		7.8	
	Hollow shaft Ø60		3.95		4.36		4.78		5.19		6.01		6.83	
Weight without position feedback With B5 flange (6)(7)	Solid shaft	kg	6.9		8.8		10.7		12.6		16.7		20.6	
	Hollow shaft Ø30		6.6		8.5		10.4		12.3		16.4		20.3	
	Blind shaft Ø56		7.65		9.7		11.8		13.8		17.8		21.9	
	Blind shaft Ø60		7.35		9.3		11.3		13.2		17.1		21	
Weight with resolver and B5 flange (6)	Hollow shaft Ø56	kg	12.65		14.6		16.55		18.5		22.6		26.5	
	Hollow shaft Ø60		12.25		14.1		16		17.8		21.8		25.5	
Thermal time constant (1)(5)	s		850		1012		1206		1399		1667		1866	
Thermal resistance (1)(5)	°C/W		0.447		0.394		0.36		0.324		0.275		0.239	
Phase resistance at 20°C (2)	Ω		21.6	7.9	12.9	2.55	7.52	1.43	6.2	0.95	3.46	0.55	2.51	0.38
Phase inductance at I continuous	mH		72	25.8	66.7	12.4	47.8	9.1	44.5	6.8	28.2	4.5	22.2	3.4
Electrical time constant (2)	ms		3.4		5.1		6.4		7.2		8.2		8.9	
Back emf constant (line to line) (2)	V/rad.s		3.13	1.86	4.25	1.91	4.38	1.91	4.88	1.91	4.78	1.91	4.88	1.91
Power cable square section	nxmm <sup>2</sup>		4x1.5		4x1.5		4x1.5		4x1.5		4x1.5		4x1.5	
Power cable diameter	mm		Ø8.6		Ø8.6		Ø8.6		Ø8.6		Ø8.6		Ø8.6	
Number of poles			12											

- (1) Ambient temperature: 20°C,  
Winding temperature rise: 120°C  
Motor in natural convection mounted on a □150 flange.
- (2) Cold motor at 20°C
- (3) See torque vs speed characteristics on :  
<http://www.alxion.com/>

- (4) Consider a 7% derating with position feedback codes 2, 7, A & B.
- (5) Housing – ambient
- (6) B14 flange: +0.2 kg

- (7) (8) Weight & Inertia function of feedback option
- |                   |            |   |
|-------------------|------------|---|
| 1                 | : + 1.5 kg | + 1.50.10 <sup>-3</sup> kg.m <sup>2</sup> |
| 2, 7, A & B       | : + 1.2 kg | + 0.34.10 <sup>-3</sup> kg.m <sup>2</sup> |
| 3                 | : + 0.34kg | + 0.15.10 <sup>-3</sup> kg.m <sup>2</sup> |
| 4, 5, 8, 9, C & D | : + 0.25kg | + 2.60.10 <sup>-6</sup> kg.m <sup>2</sup> |
| 6                 | : + 0.1 kg | + 2.50.10 <sup>-6</sup> kg.m <sup>2</sup> |

### Maximum load for a 20 000h life time and axial load < 30% of radial load

145 ST with solid shaft

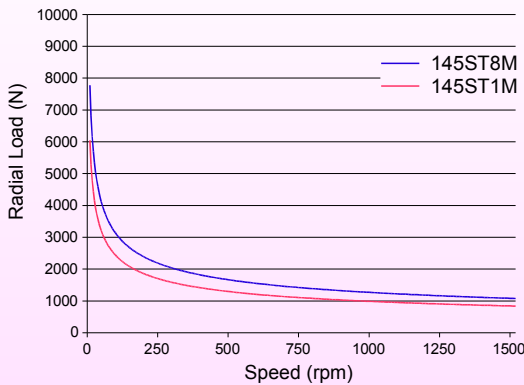

145ST with hollow shaft Ø30

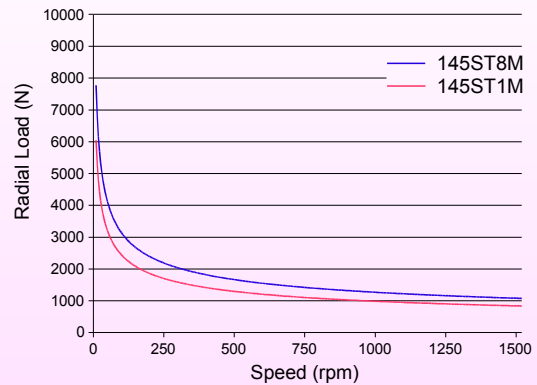

145ST with blind shaft Ø56 & Ø60

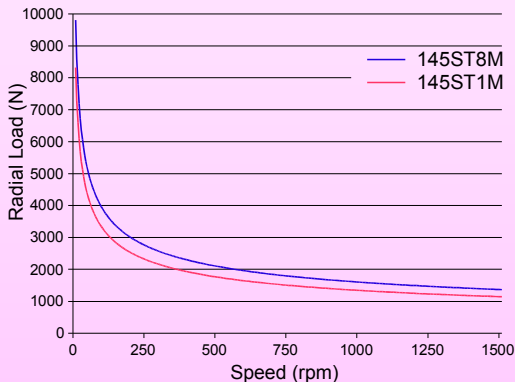

145ST with hollow shaft Ø56 & Ø60

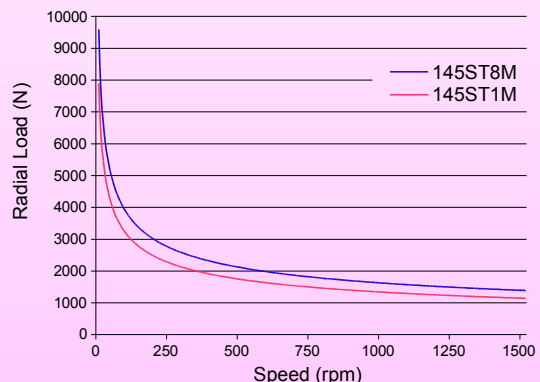

The values of load are given:  
 - For a smooth operation without shock.  
 - In rated conditions of motor operation.  
 - For a load applied in the middle of the shaft end.  
 The shaft end, on its own, cannot support the whole maximum load applied punctually.  
 In some cases, repartition of the load should be necessary, please contact us.  
 For atypical conditions (shocks, vibrations, temperature, environment), please contact us.

# TORQUE VS SPEED CURVES MOTORS 145ST

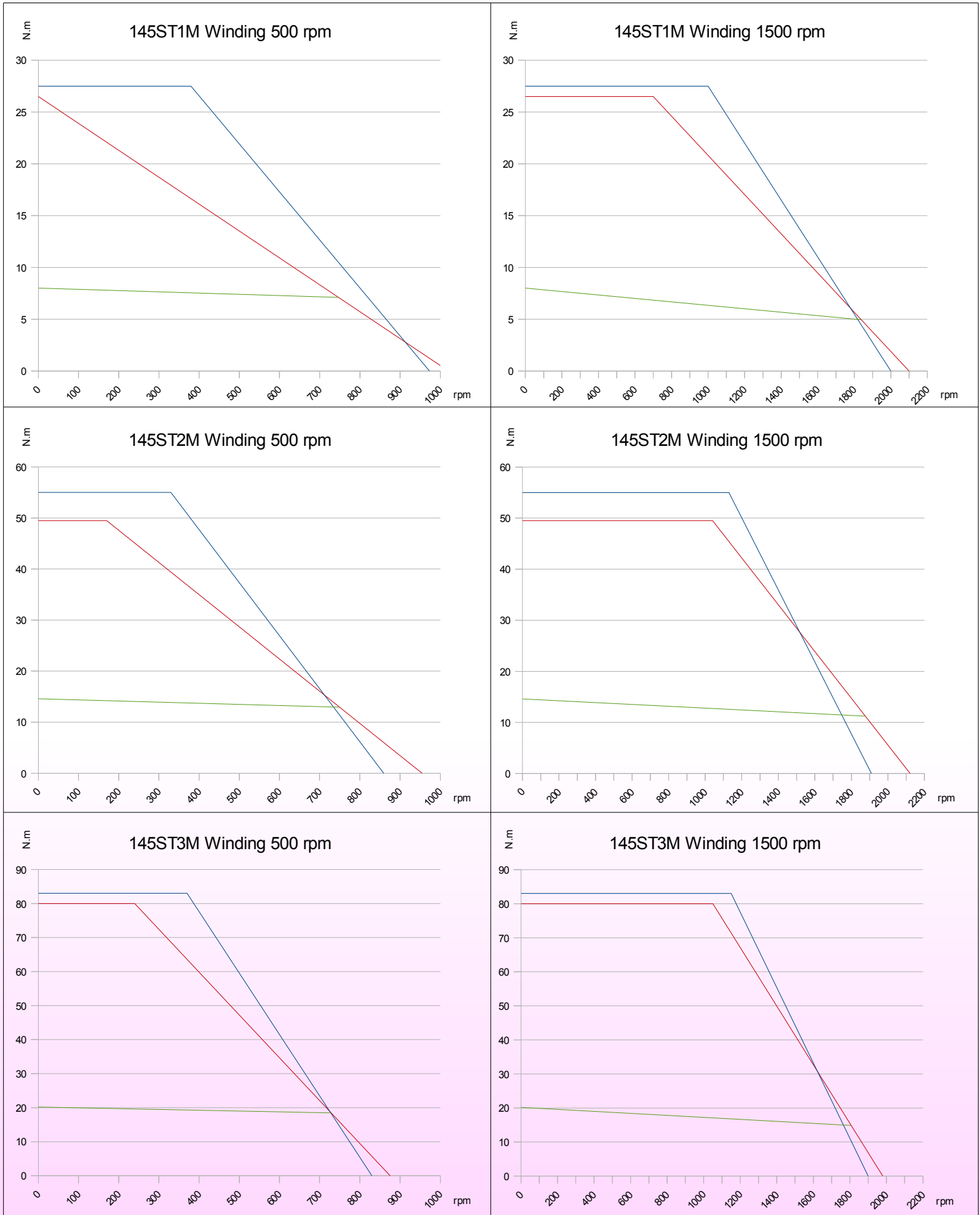

- Continuous torque with natural convection
- Max. transient characteristics motor at 20°C 400VAC mains / 540VDC bus with flux vector control
- Max. transient characteristics motor at rated temp 400VAC mains / 540VDC bus with flux vector control

Other windings can be supplied for matching your needs ; please contact us.

# TORQUE VS SPEED CURVES MOTORS 145ST

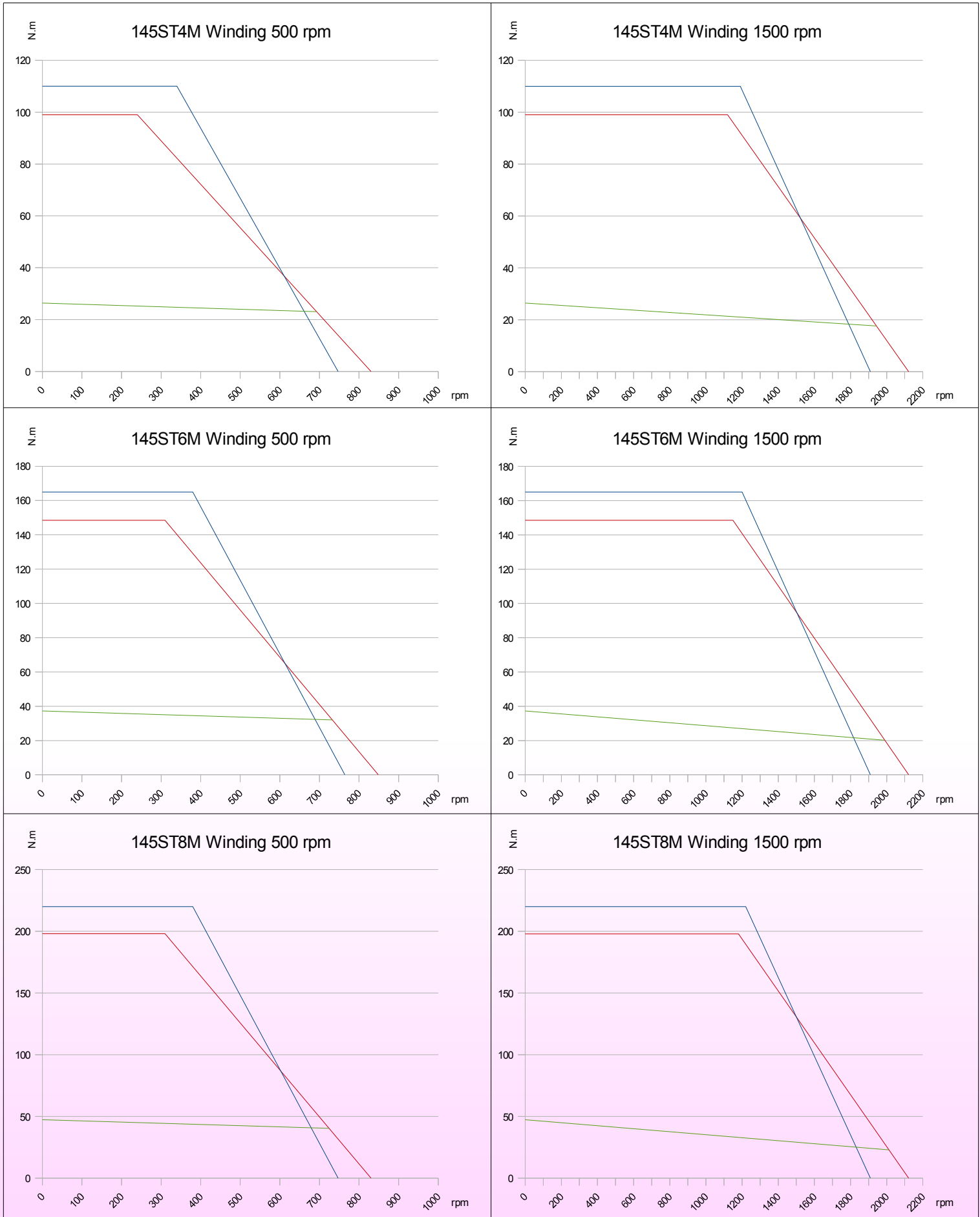

- Continuous torque with natural convection
- Max. transient characteristics motor at 20°C 400VAC mains / 540VDC bus with flux vector control
- Max. transient characteristics motor at rated temp 400VAC mains / 540VDC bus with flux vector control

Other windings can be supplied for matching your needs ; please contact us.



# 145ST MOTORS DIMENSIONS

## 145ST MOTORS WITH SOLID SHAFT (figure 1)

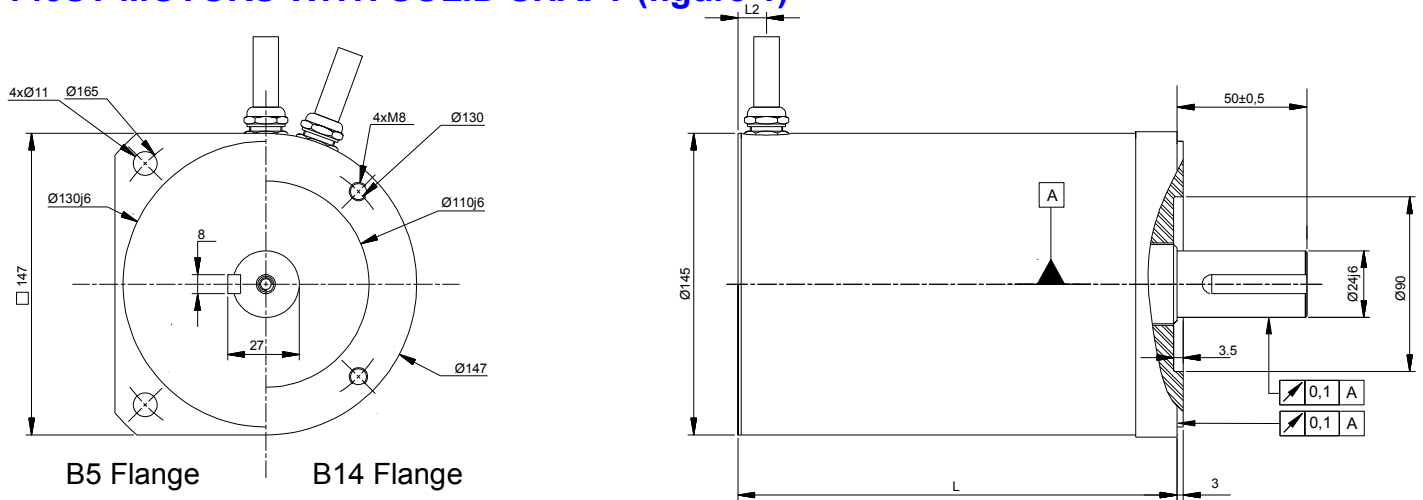

Keyway is optional, see codification for ST motors

## 145ST MOTORS WITH HOLLOW OR BLIND SHAFT (figure 2)

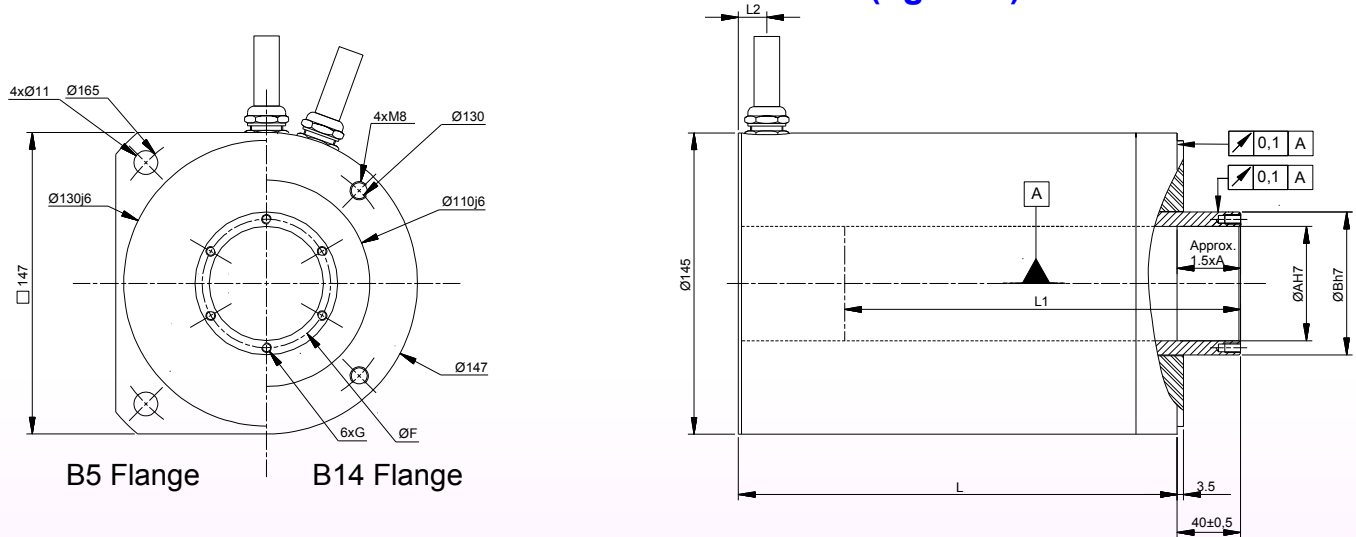

Power and signal are class 6 shielded cables (see marking P23)

All dimensions are in mm

MOTOR	Solid shaft (fig 1)				Hollow shaft Ø30 (fig 2)		Blind shaft Ø56 (fig 2)				Hollow shaft Ø56 (fig 2)	Blind shaft Ø60 (fig 2)		Hollow shaft Ø60 (fig 2)		
	L				G=M5 F=37.5 A=30 B=45		G=M6 F=65.5 A=56 B=75				G=M6 F=65.5 A=56 B=75	No threads A=60 B=75		No threads A=60 B=75		
	L2=66		L2=21		L		L			L1	L	Same length dimensions as Ø56 blind shaft motor		Same length dimensions as Ø56 hollow shaft motor		
Position Feedback (Page 10)	1	3	4 5 8 9 C D	6	1 3	2 7 A B	L2=66		L2=21		ALL					1
145ST1M	168.50	140.00	150.00	132.00	Same length dimensions as solid shaft motor	166.00	185.00	156.50	166.50	148.50	108.00	185.00				
145ST2M	195.50	167.00	177.00	159.00		193.00	212.00	183.50	193.50	175.50	135.00	212.00				
145ST3M	222.50	194.00	204.00	186.00		220.00	239.00	210.50	220.50	202.50	162.00	239.00				
145ST4M	249.50	221.00	231.00	213.00		247.00	266.00	237.50	247.50	229.50	189.00	266.00				
145ST5M	276.50	248.00	258.00	240.00		274.00	293.00	264.50	274.50	256.50	216.00	293.00				
145ST6M	303.50	275.00	285.00	267.00		301.00	320.00	291.50	301.50	283.50	243.00	320.00				
145ST7M	330.50	302.00	312.00	294.00		328.00	347.00	318.50	328.50	310.50	270.00	347.00				
145ST8M	357.50	329.00	339.00	321.00		355.00	374.00	345.50	355.50	337.50	297.00	374.00				

Note: ALXION keeps the right to modify all data without prior notice

# CODIFICATION FOR 145ST MOTORS



145 ST X M Y Z T B WW L H

Size









1	1 M
2	2 M
3	3 M
4	4 M
5	5 M
6	6 M
7	7 M
8	8 M

See technical characteristics & dimensions on previous pages

Flange

1		B14
2		B5
?		Contact us !

Shaft

		Ø int	Ø ext
1		Ø56	Ø75
2		Ø30	Ø45
3		Ø56	Ø75
4		x	Ø24
5		x	Ø24
6		Ø60	Ø75
7		Ø60	Ø75
?			

Position feedback

1	RESOLVER ALXION ±1'
2	ENCODER ERN 180 2048 pts
3	ENCODER SCK KIT 101
4	ENCODER ERN 1387
5	ENCODER ERN 1381
6	RESOLVER STANDARD ±10'
7	ENCODER ECN 113
8	ENCODER ECN 1313
9	ENCODER EQN 1325
A	ENCODER ERN 180 5000 pts
B	ENCODER ECN 125
C	ENCODER ECN 1325
D	ENCODER EQN 1337
?	Contact us !

See position feedback descriptions on page 22

Winding code

Cable length

Motor technology

H	High precision Cogging torque < 1 %
S	Standard precision Cogging torque ≤ 2 %

0	2 meters
1	4 meters
2	6 meters
3	8 meters
4	10 meters
5	15 meters
6	20 meters
7	25 meters
8	30 meters
9	40 meters
?	Contact us !

01	Standard low speed
02	Standard high speed
?	Contact us !

## Standard possible configurations :

Shaft		Possible position feedback	
Hollow shaft	1 or 7	Resolver Encoder	1 No
	2	Resolver Encoder	1 2, 3, 7, A or B
Blind shaft	3 or 6	Resolver Encoder	1 or 6 3, 4, 5, 8, 9, C or D
Solid shaft	4 or 5	Resolver Encoder	1 or 6 3, 4, 5, 8, 9, C or D

# 190ST MOTORS

Continuous torque : from 36 N.m up to 111 N.m

Peak torque : from 62 N.m up to 496 N.m

Hollow shaft : up to 75 mm

Rated speed : from 500 rpm up to 1500 rpm

# TECHNICAL CHARACTERISTICS 190ST

## Windings for 400V / 460Vac drives (See Application note)

			190ST1M		190ST2M		190ST3M		190ST4M		190ST6M		190ST8M					
Rated speed			rpm		500	1500	500	1500	500	1500	500	1000	500	1000				
Continuous torque at stall (4)			N.m		19		36		49		63		111					
Current at continuous torque (1)			A		3	6.5	4.5	11.7	5.9	13.2	7.1	19.3	11.1	20	13.3	23.3		
Peak torque (2)(3)			N.m		62		124		186		248		372		496			
Current at peak torque (2)			A		11.8	25.6	18.6	48.9	27	60.3	34.2	93.2	56.9	102.5	73.2	128.1		
Rated power (1)			W		910	2560	1730	4230	2360	5259	3024	6590	4250	7085	5250	8530		
Inertia without position feedback (8)			Solid shaft		10 <sup>-3</sup> kg.m <sup>2</sup>		3.02		4.5		5.98		7.46		10.43		13.4	
					Hollow shaft Ø40		2.94		4.42		5.9		7.39		10.36		13.32	
					Blind shaft Ø72		5.98		7.46		8.95		10.43		13.39		16.36	
					Blind shaft Ø75		5.55		6.9		8.25		9.6		12.3		15	
Inertia with resolver			Hollow shaft Ø72		10 <sup>-3</sup> kg.m <sup>2</sup>		8.67		10.16		11.65		13.13		16.1		19.06	
					Hollow shaft Ø75		7.85		9.2		10.55		11.9		14.6		17.3	
Weight without position feedback With B5 flange (6)(7)			Solid shaft		kg		15.3		19.7		24.1		28.6		37.6		46.6	
					Hollow shaft Ø40		13.7		18.2		22.7		27.2		36.2		45.1	
					Blind shaft Ø72		15.8		20.3		24.8		29.3		38.3		47.3	
					Blind shaft Ø75		15.5		19.9		24.3		28.7		37.5		46.3	
Weight with resolver and B5 flange (6)			Hollow shaft Ø72		kg		18.3		22.7		27.2		31.6		40.6		49.6	
					Hollow shaft Ø75		17.7		22		26.4		30.7		39.5		48.3	
Thermal time constant (1)(5)			s		1200		1506		1850		2129		2559		2865			
Thermal resistance (1)(5)			°C/W		0.28		0.253		0.228		0.203		0.17		0.146			
Phase resistance at 20°C (2)			Ω		9.45	2	4.76	0.69	2.76	0.597	2.12	0.28	1.02	0.31	0.77	0.25		
Phase inductance at I continuous			mH		55.2	11.8	48.2	7	31.7	6.4	28.8	3.9	15.7	4.8	12.7	4.1		
Electrical time constant (2)			ms		5.9		10.1		10.7		13.6		15.6		16.5			
Back emf constant (line to line) (2)			V/rad.s		4.06	1.77	5.13	1.96	5.32	2.38	5.6	2.05	5.04	2.8	5.22	2.99		
Power cable square section			nxmm <sup>2</sup>		4x1.5		4x1.5		4x1.5		4x1.5		4x2.5		4x1.5		4x4	
Power cable diameter			mm		Ø8.6		Ø8.6		Ø8.6		Ø8.6		Ø10.8		Ø8.6		Ø12.2	
Number of poles					12													

- (1) Ambient temperature: 20°C,  
Winding temperature rise: 120°C  
Motor in natural convection mounted on a □200 flange.
- (2) Cold motor at 20°C
- (3) See torque vs speed characteristics on :  
<http://www.alxion.com/>

- (4) Consider a 7% derating with position feedback codes 2, 7, A & B.
- (5) Housing – ambient
- (6) B14 flange: +0.4 kg

- (7) (8) Weight & Inertia function of feedback option
- |                   |             |   |
|-------------------|-------------|---|
| 1                 | : + 1.5 kg  | + 1.50.10 <sup>-3</sup> kg.m <sup>2</sup> |
| 2, 7, A & B       | : + 1.2 kg  | + 0.34.10 <sup>-3</sup> kg.m <sup>2</sup> |
| 3                 | : + 0.34kg  | + 0.15.10 <sup>-3</sup> kg.m <sup>2</sup> |
| 4, 5, 8, 9, C & D | : + 0.25kg  | + 2.60.10 <sup>-6</sup> kg.m <sup>2</sup> |
| 6                 | : + 0.1 kg  | + 2.50.10 <sup>-6</sup> kg.m <sup>2</sup> |
| E & F             | : + 0,44 kg | + 0,42.10 <sup>-6</sup> kg.m <sup>2</sup> |

### Maximum load for a 20 000h life time and axial load < 30% of radial load

190ST with solid shaft

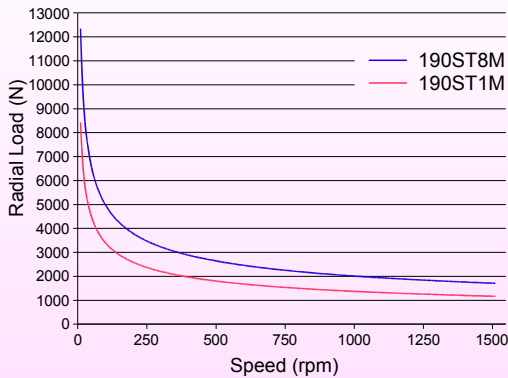

190ST with hollow shaft Ø40

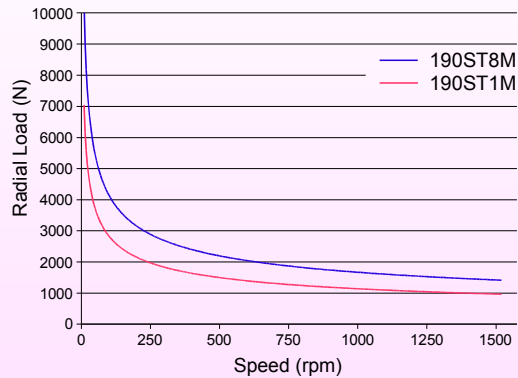

190ST with blind shaft Ø72 & Ø75

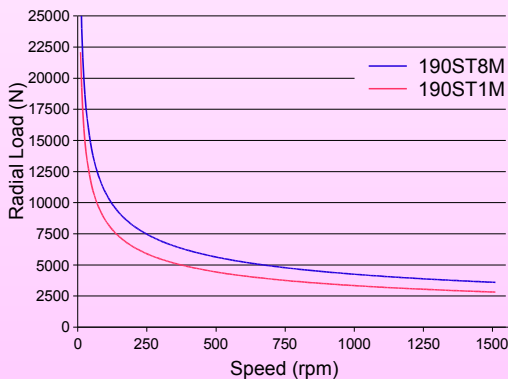

190ST with hollow shaft Ø72 & Ø75

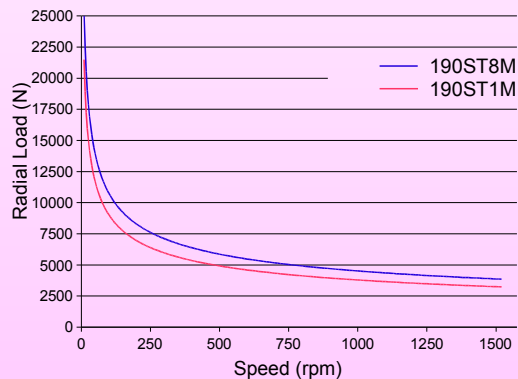

The values of load are given:

- For a smooth operation without shock.
- In rated conditions of motor operation.
- For a load applied in the middle of the shaft end.

The shaft end, on its own, cannot support the whole maximum load applied punctually. In some cases, repartition of the load should be necessary, please contact us.

For atypical conditions (shocks, vibrations, temperature, environment), please contact us.

# TORQUE VS SPEED CURVES MOTORS 190ST

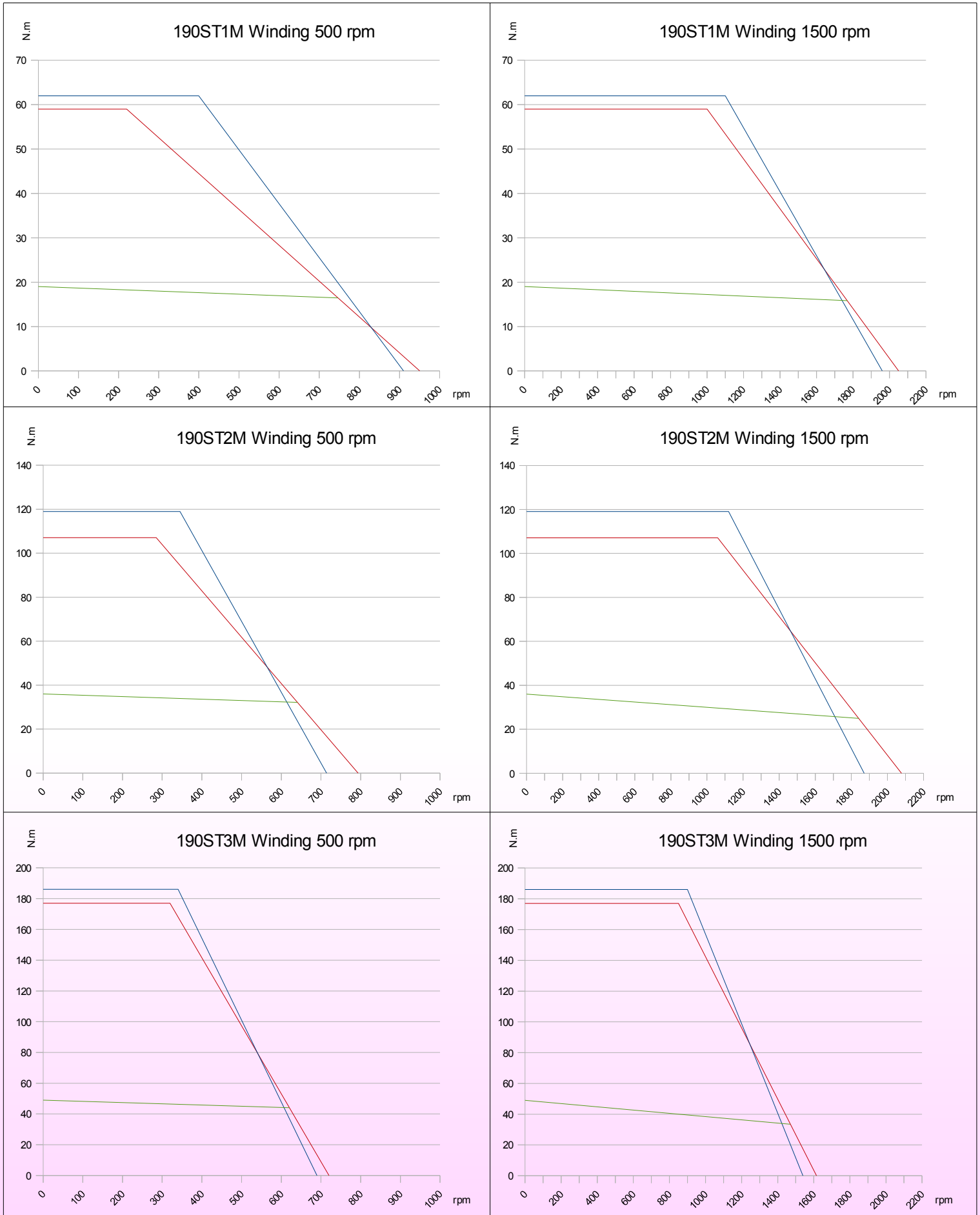

- Continuous torque with natural convection
- Max. transient characteristics motor at 20°C 400VAC mains / 540VDC bus with flux vector control
- Max. transient characteristics motor at rated temp 400VAC mains / 540VDC bus with flux vector control

Other windings can be supplied for matching your needs ; please contact us.

# TORQUE VS SPEED CURVES MOTORS 190ST

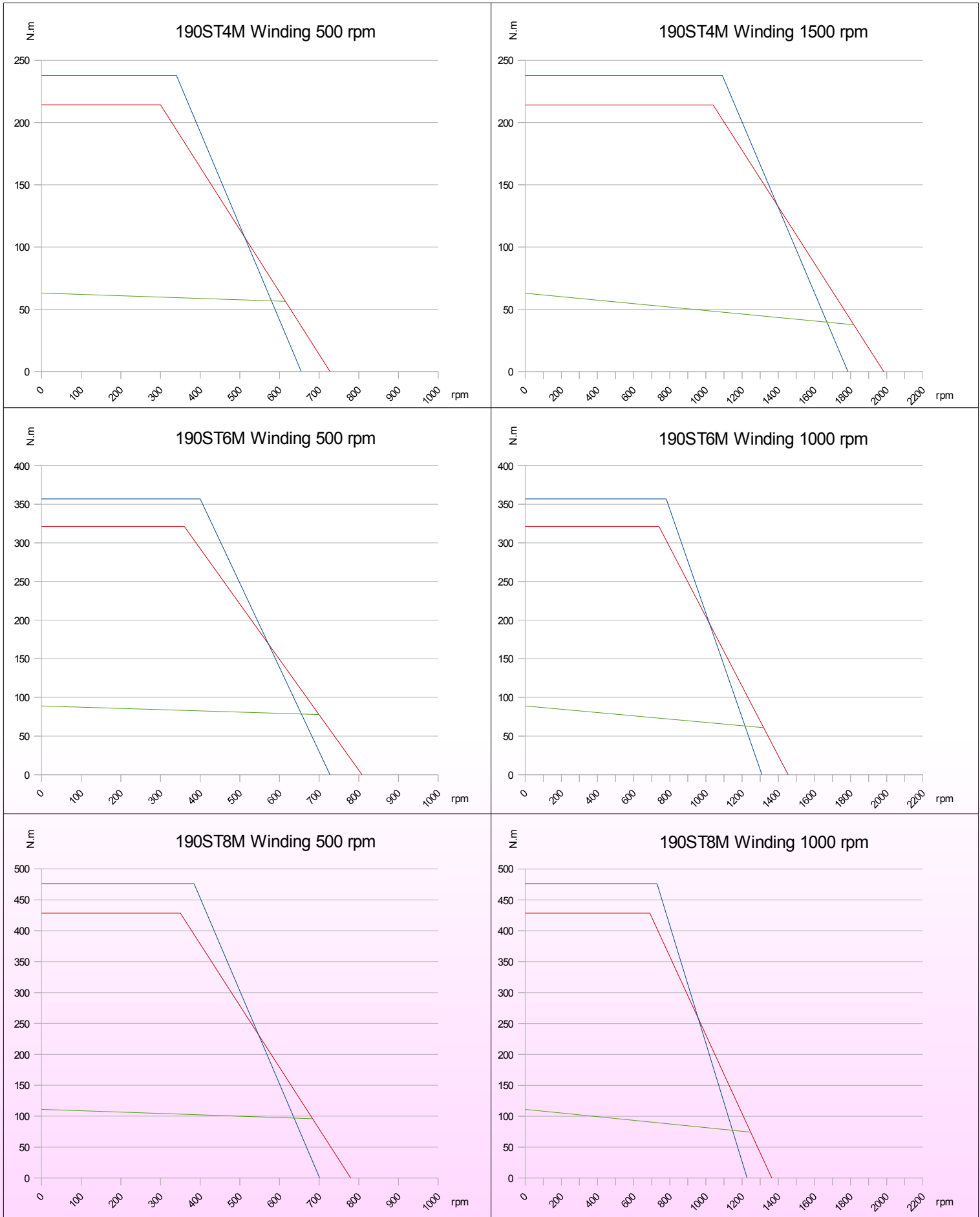

- Continuous torque with natural convection
- Max. transient characteristics motor at 20°C 400VAC mains / 540VDC bus with flux vector control
- Max. transient characteristics motor at rated temp 400VAC mains / 540VDC bus with flux vector control

Other windings can be supplied for matching your needs ; please contact us.

# 190ST MOTORS DIMENSIONS

## 190ST MOTORS WITH SOLID SHAFT (figure 1)

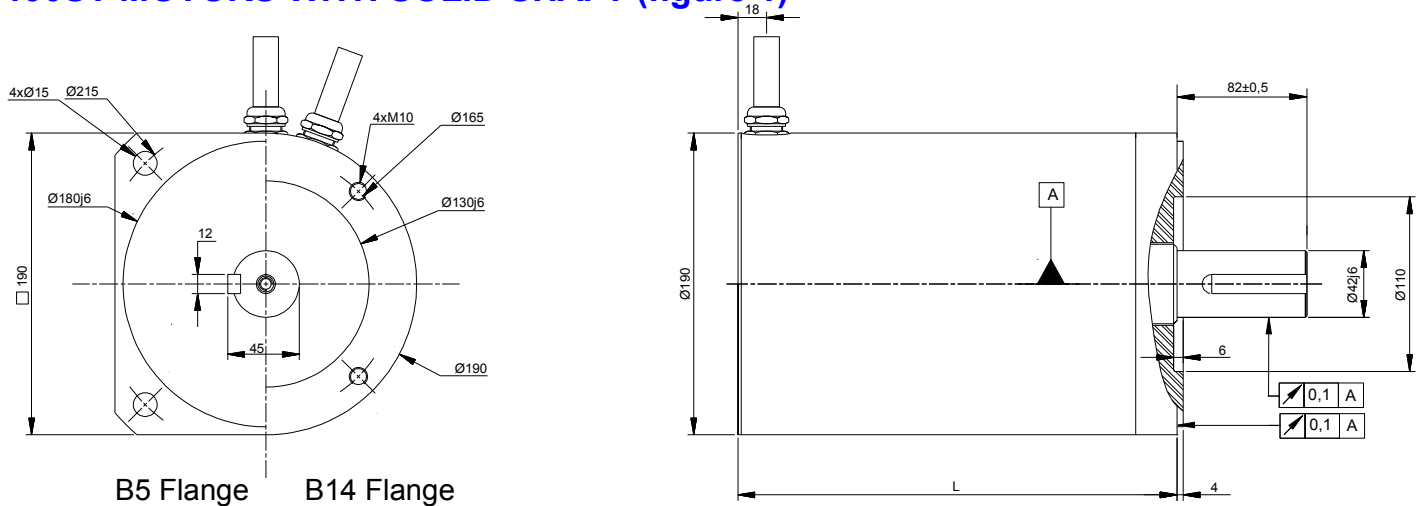

Keyway is optional, see codification for ST motors

## 190ST MOTORS WITH HOLLOW OR BLIND SHAFT (figure 2)

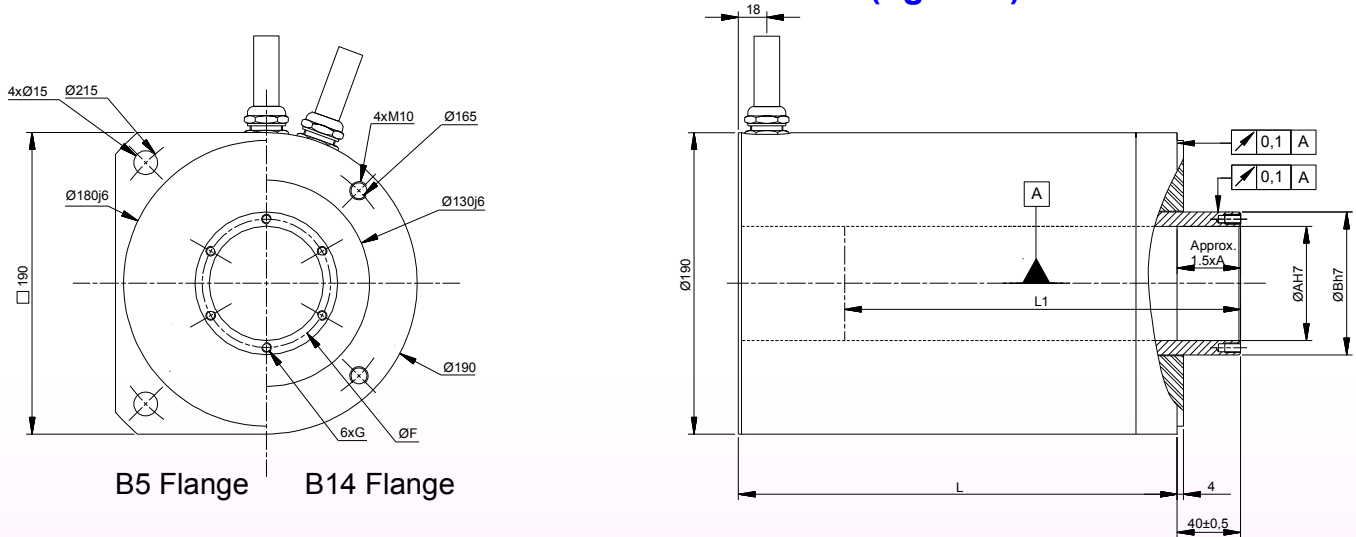

Power and signal are class 6 shielded cables (see marking P23)

MOTOR	Solid shaft (fig 1)		Hollow shaft Ø40 (fig 2)		Blind shaft Ø72 (fig 2)			Hollow shaft Ø72 (fig 2)	Blind shaft Ø75 (fig 2)	Hollow shaft Ø75 (fig 2)
	L		G=M5 F=47.5 A=40 B=55		G=M6 F=81 A=72 B=90		G=M6 F=81 A=72 B=90	L	No threads A=75 B=90	No threads A=75 B=90
Position Feedback (Page 10)	1 3 6	4 5 8 9 C D	1 3	2 7 A B	1 3 6	4 5 8 9 C D	ALL	1 E F	Same length dimensions as Ø72 blind shaft motor	Same length dimensions as Ø72 hollow shaft motor
190ST1M	167.75	178.75	167.75	205.75	175.25	186.25	116.25	198.75		
190ST2M	204.00	215.00	204.00	242.00	211.50	222.50	152.50	235.00		
190ST3M	240.25	251.25	240.25	278.25	247.75	258.75	188.75	271.25		
190ST4M	276.50	287.50	276.50	314.50	284.00	295.00	225.00	307.50		
190ST5M	312.75	323.75	312.75	350.75	320.25	331.25	261.25	343.75		
190ST6M	349.00	360.00	349.00	387.00	356.50	367.50	297.50	380.00		
190ST7M	385.25	396.25	385.25	423.25	392.75	403.75	333.75	416.25		
190ST8M	421.50	432.50	421.50	459.50	429.00	440.00	370.00	452.50		

Note: ALXION keeps the right to modify all data without prior notice

# CODIFICATION FOR 190ST MOTORS



190 ST X M Y Z T B WW L H

Size









1	1 M
2	2 M
3	3 M
4	4 M
5	5 M
6	6 M
7	7 M
8	8 M

See technical characteristics & dimensions on previous pages

Flange

1		B14
2		B5
?		Contact us !

Shaft

		Ø int	Ø ext
1		HOLLOW SHAFT	Ø72 Ø90
2		HOLLOW SHAFT	Ø40 Ø55
3		BLIND SHAFT	Ø72 Ø90
4		KEYED SHAFT	x Ø42
5		SOLID SHAFT	x Ø42
6		BLIND SHAFT	Ø75 Ø90
7		HOLLOW SHAFT	Ø75 Ø90
?		Contact us !	

Position feedback

1	RESOLVER ALXION ±1'
2	ENCODER ERN 180 2048 pts
3	ENCODER SCK KIT 101
4	ENCODER ERN 1387
5	ENCODER ERN 1381
6	RESOLVER STANDARD ±10'
7	ENCODER ECN 113
8	ENCODER ECN 1313
9	ENCODER EQN 1325
A	ENCODER ERN 180 5000 pts
B	ENCODER ECN 125
C	ENCODER ECN 1325
D	ENCODER EQN 1337
E	ENCODER ECI 4010
F	ENCODER EBI 4010
?	Contact us !

See position feedback descriptions on page 22

Winding code

Cable length

Motor technology

H	High precision Cogging torque < 1 %
S	Standard precision Cogging torque ≤ 2 %

0	2 meters
1	4 meters
2	6 meters
3	8 meters
4	10 meters
5	15 meters
6	20 meters
7	25 meters
8	30 meters
9	40 meters
?	Contact us !

01	Standard low speed
02	Standard high speed
?	Contact us !

## Standard possible configurations :

Shaft		Possible position feedback	
Hollow shaft	1 or 7	Resolver	1
		Encoder	E or F
Blind shaft	2	Resolver	1
		Encoder	2, 3, 7, A or B
Solid shaft	3 or 6	Resolver	1 or 6
		Encoder	3, 4, 5, 8, 9, C or D
Solid shaft	4 or 5	Resolver	1 or 6
		Encoder	3, 4, 5, 8, 9, C or D



# 300ST MOTORS

Continuous torque : from 54 N.m up to 261 N.m

Peak torque : from 193 N.m up to 1161 N.m

Hollow shaft : up to 72 mm

Rated speed : from 200 rpm up to 800 rpm

# TECHNICAL CHARACTERISTICS 300ST

## Windings for 400V / 460Vac drives (See Application note)

	rpm	300ST1M		300ST2M		300ST3M		300ST4M		300ST5M		300ST6M	
		200	800	200	800	200	800	200	800	200	800	200	800
Rated speed													
Continuous torque at stall (4)	N.m	54		98		145		184		224		261	
Current at continuous torque (1)	A	4.1	10.5	7	17.6	9	27	11.2	36	13.4	43.8	15.5	48.5
Peak torque (2)(3)	N.m	193		387		580		774		968		1161	
Current at peak torque (2)(3)	A	20.9	53.2	36.7	92.6	50.6	152	66.5	212.9	81.9	266.1	96.8	304.1
Rated power (1)	KW	1.06	3.65	2	7.06	2.89	8.9	3.65	10.92	4.2	12.43	4.7	13.86
Inertia without position feedback (7)	10 <sup>-3</sup> kg.m <sup>2</sup>	60.1		87		113.9		140.8		167.7		194.7	
Weight without position feedback (6)	kg	31.4		38		44.5		51		57.5		64.1	
Thermal time constant (1)(5)	s	495		669		907		1145		1381		1621	
Thermal resistance (1)(5)	°C/W	0.184		0.164		0.15		0.135		0.125		0.115	
Phase resistance at 20°C (2)	Ω	6.55	1.01	2.82	0.44	1.85	0.205	1.286	0.126	0.99	0.094	0.808	0.082
Phase inductance at I continuous	mH	27.4	4.2	17.7	2.8	13.9	1.53	11.1	1.1	8.9	0.83	7.8	0.8
Electrical time constant (2)	ms	4.2		6.3		7.5		8.6		9		9.7	
Back emf constant (line to line) (2)	V/rad.s	8.02	3.15	9.13	3.62	9.93	3.31	10.07	3.15	10.2	3.14	10.38	3.31
Number of poles		24											

- (1) Ambient temperature: 20°C,  
Winding temperature rise: 120°C  
Motor in natural convection mounted on a □350 flange.
- (2) Cold motor at 20°C
- (3) See torque vs speed characteristics on :  
<http://www.alxion.com/>
- (4) Consider a 7% derating with position feedback codes 2, 7, A & B.
- (5) Housing – ambient
- (6) (7) Weight & Inertia function of feedback option
- |             |             |   |
|-------------|-------------|---|
| 1           | : + 1.5 kg  | + 1.50.10 <sup>-3</sup> kg.m <sup>2</sup> |
| 2, 7, A & B | : + 2.3 kg  | + 0.89.10 <sup>-3</sup> kg.m <sup>2</sup> |
| 3           | : + 1.44kg  | + 0.70.10 <sup>-3</sup> kg.m <sup>2</sup> |
| E & F       | : + 0.44 kg | + 0.42.10 <sup>-3</sup> kg.m <sup>2</sup> |

## CONNECTORS DESCRIPTION

### Power connector :

#### Current at continuous torque < 25 A :

Fixed male B-EG-A-127-MR23-00-0006-000  
Mobile plug B-ST-A-107-FR23-43-0236-000

- 1 : Phase U  
2 : Phase V  
3 : Ground  
4 : Phase W

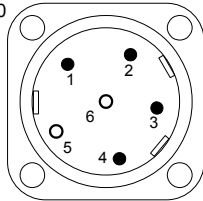

#### Current at continuous torque >25 A :

Fixed male C-EG-A-257-MR48-00-0004-000  
Mobile plug C-ST-A-263-FR52-26-0001-000

- U : Phase U  
V : Phase V  
W : Phase W  
⊥ : Ground

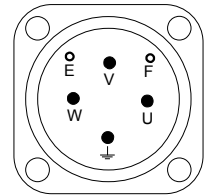

### Signal connector :

Fixed male A-EG-A-052-MR04-00-0012-000  
Mobile plug A-ST-A-020-FR01-10-0035-000

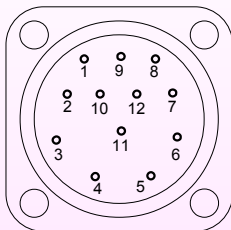

Signal connector description					
	Résolver	Encoder Sick® SCK KIT 101	Encoder Heidenhain® ERN180	Encoder Heidenhain® ECN 113	Encoder Heidenhain® EC4010, EB4010 & ECN125
1	Input Carrier +	Us	Up	Up	Up
2	Input Carrier -	GND	0V	0V	0V
3	Sin +	Sin +	A +	A +	DATA +
4	Sin -	Sin -	A -	A -	DATA -
5	Cos +	Cos +	B +	B +	CLOCK +
6	Cos -	Cos -	B -	B -	CLOCK -
7		DATA +	R+	DATA +	
8		DATA -	R -	DATA -	
9	KTY	KTY	KTY	CLOCK +	KTY
10	KTY	KTY	KTY	CLOCK -	KTY
11	PTC	PTC	PTC	Thermal	PTC

## Axial and radial load for a 20 000 hours life time

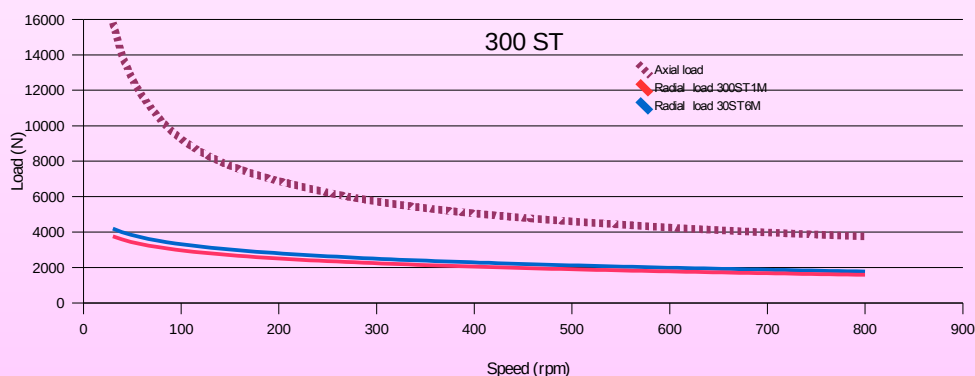

The values of load are given:  
 - For a smooth operation without shock.  
 - In rated conditions of motor operation.  
 For atypical conditions (shocks, vibrations, temperature, environment), please contact us.

# TORQUE VS SPEED CURVES MOTORS 300ST

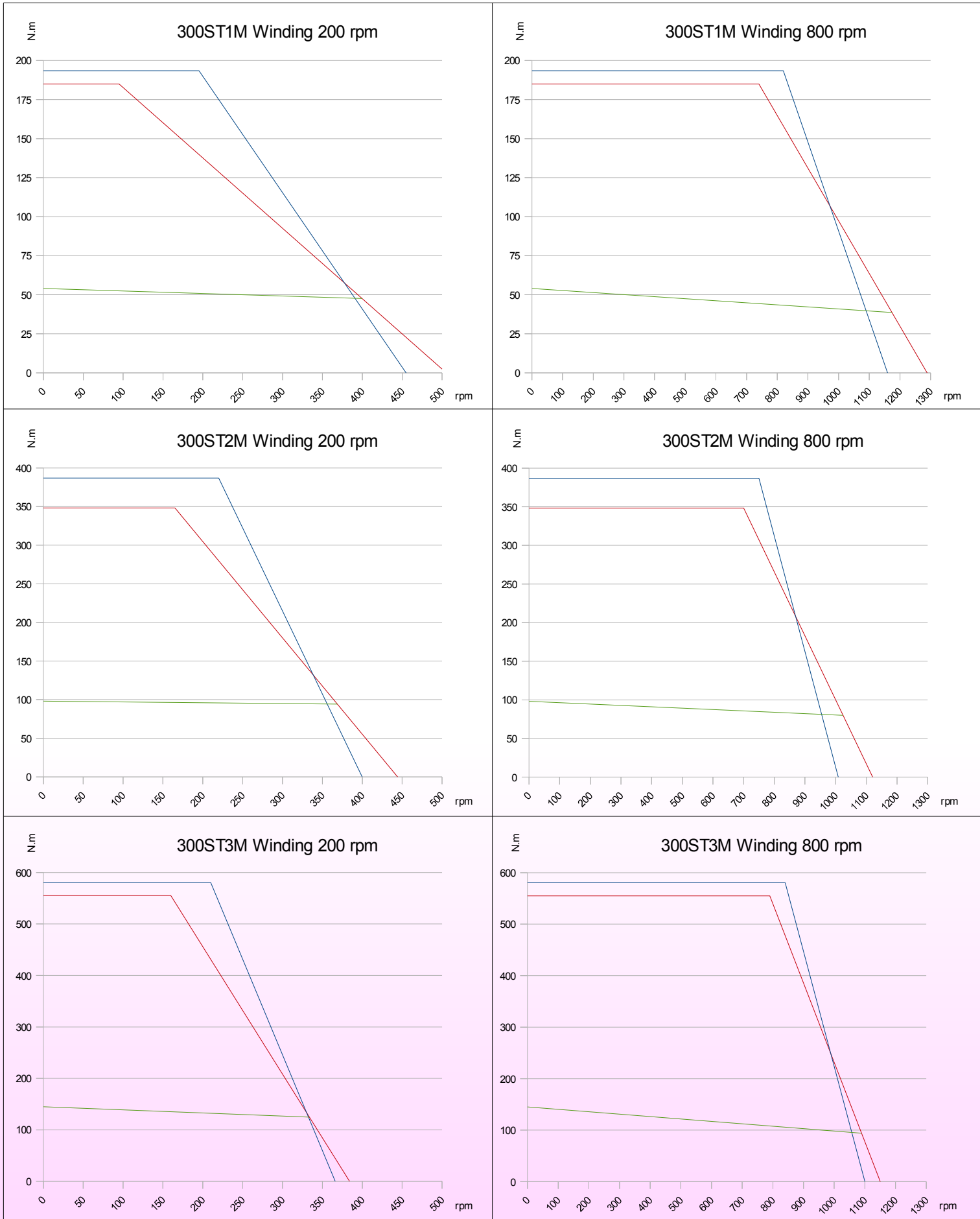

- Continuous torque with natural convection
- Max. transient characteristics motor at 20°C 400VAC mains / 540VDC bus with flux vector control
- Max. transient characteristics motor at rated temp 400VAC mains / 540VDC bus with flux vector control

Other windings can be supplied for matching your needs ; please contact us.

# TORQUE VS SPEED CURVES MOTORS 300ST

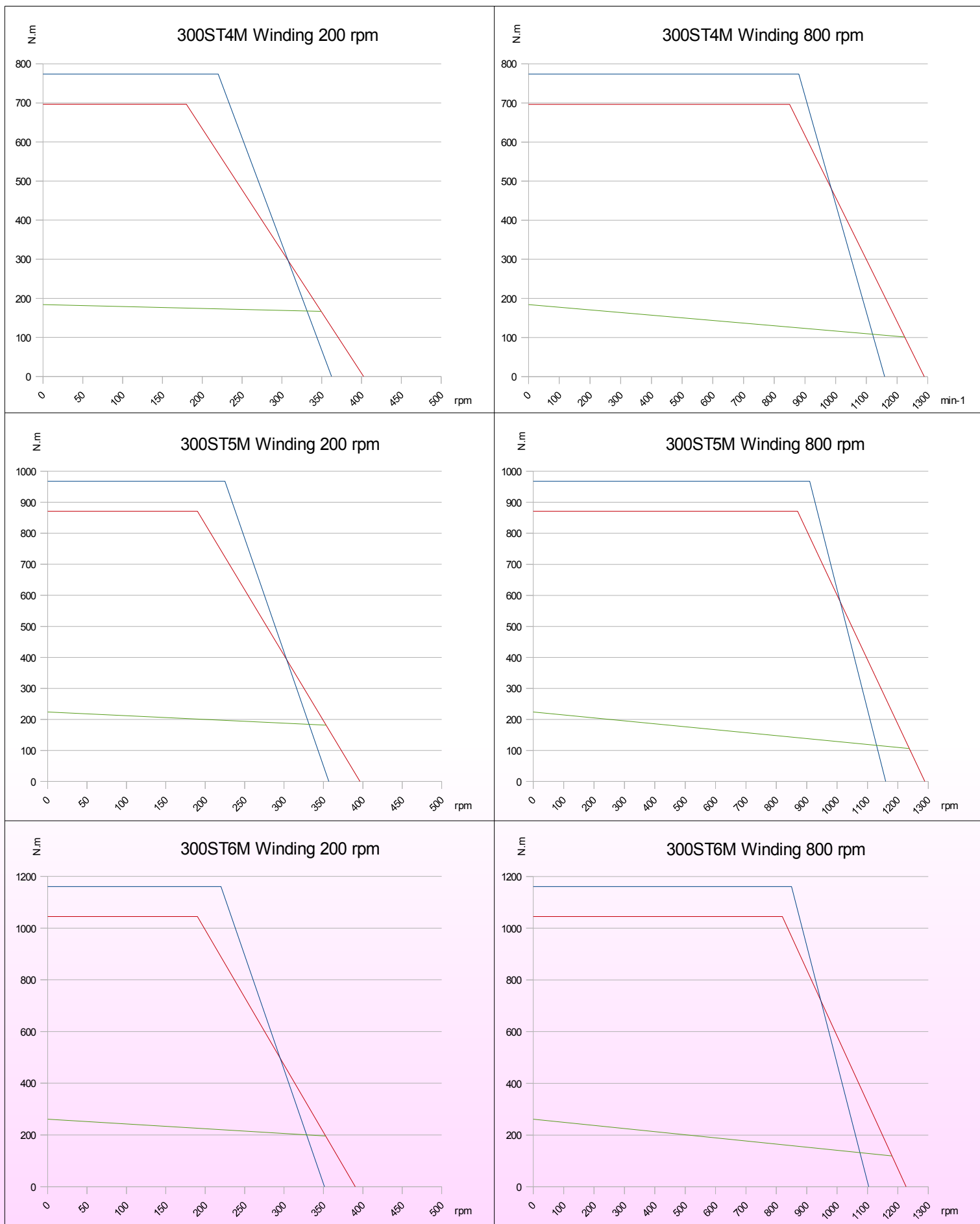

- Continuous torque with natural convection
- Max. transient characteristics motor at 20°C 400VAC mains / 540VDC bus with flux vector control
- Max. transient characteristics motor at rated temp 400VAC mains / 540VDC bus with flux vector control

Other windings can be supplied for matching your needs ; please contact us.

# 300ST MOTORS DIMENSIONS

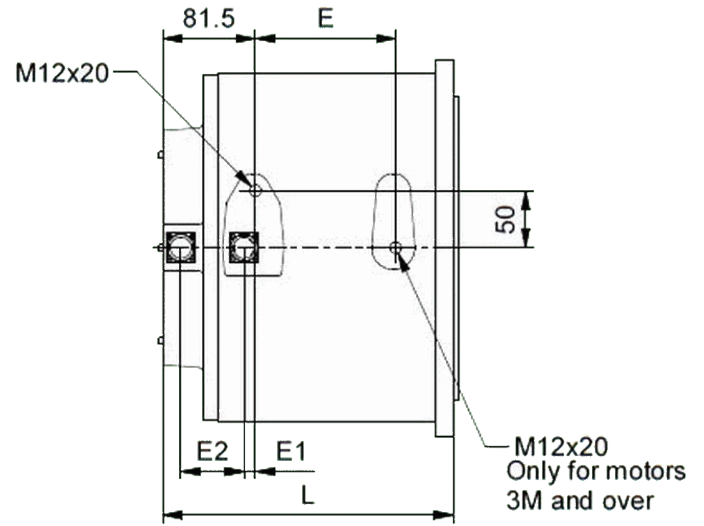
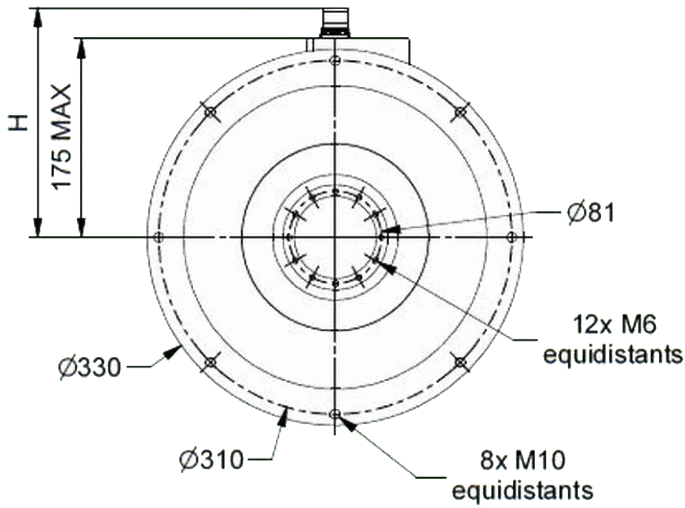

With position feedback 1, E or F  
(fig. 1)

With position feedback 2, 3, 7, A or B  
(fig. 2)

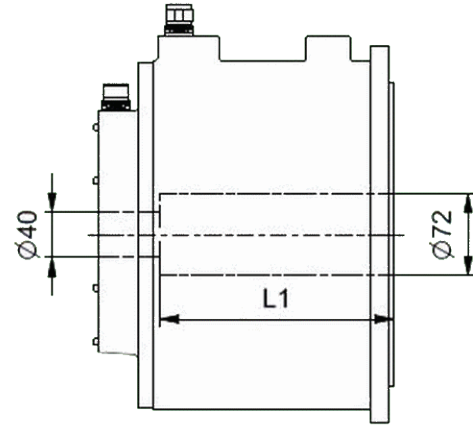
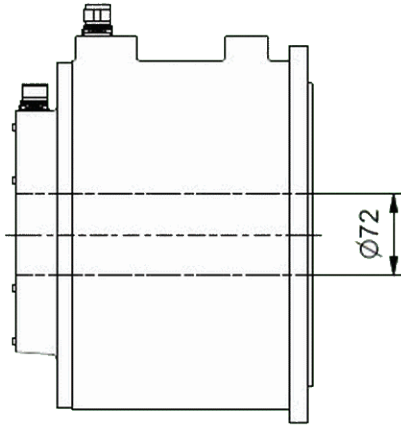

Current at continuous torque	H	E1	E2
< 25 A	202	10	55,5
> 25 A	217	2	63,5

## Front side of motors 300ST

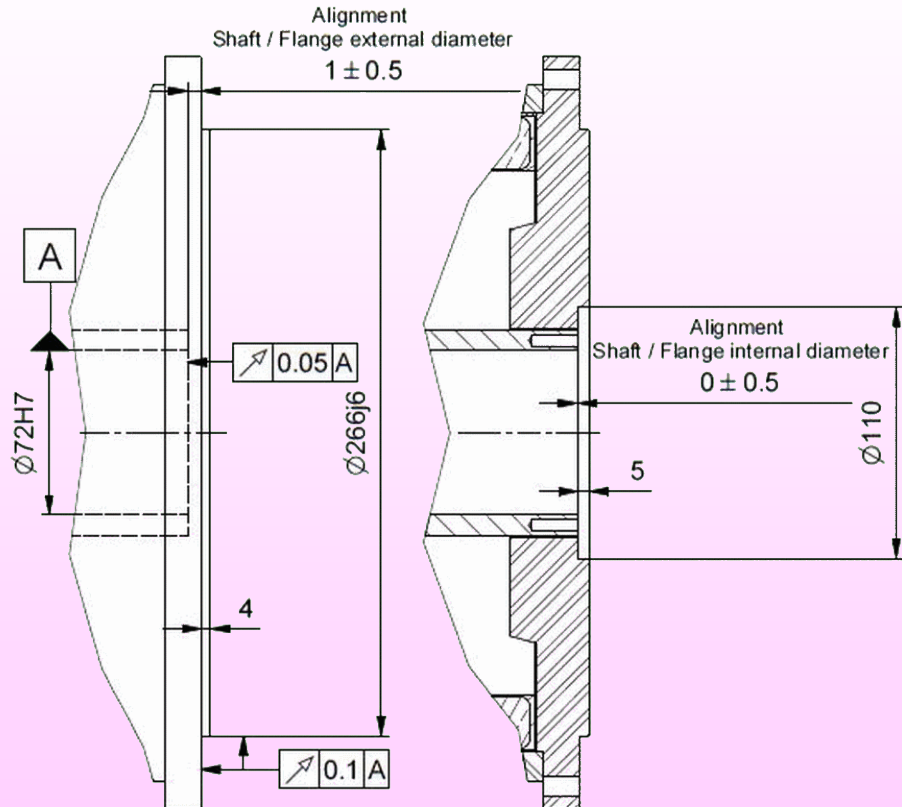

MOTOR	Position feedback (page 10)				E
	1, E or F (fig. 1)	2, 7, A or B (fig. 2)	3 (fig. 2)	ALL	
Dimensions	L	L	L1	L	
300ST1M	173.5	197.5	123	173.5	
300ST2M	201	225	150.5	201	
300ST3M	228.5	252.5	178	228.5	118
300ST4M	256	280	205.5	256	123
300ST5M	283.5	307.5	233	283.5	
300ST6M	311	335	260.5	311	

All dimensions are in mm

Note: ALXION keeps the right to modify all data without prior notice

# CODIFICATION FOR 300ST MOTORS

300 ST **X** **M** **Y** **Z** **T** **B** **WW** **C** **X**

Size

1	1 M
2	2 M
3	3 M
4	4 M
5	5 M
6	6 M

See technical characteristics & dimensions on previous pages



Flange

Shaft

Position feedback

Thermal sensors

Winding code

1		B14
?		Contact us !

01	Standard low speed
02	Standard high speed
?	Contact us !

B	KTY84 & PTC
K	KTY84
P	PTC

		Ø int Input	Ø int Output
1		HOLLOW SHAFT	Ø72 Ø72
8		HOLLOW SHAFT	Ø72 Ø40
?		Contact us !	

1	RESOLVER ALXION ±1'
2	ENCODER ERN 180 2048 pts
3	ENCODER SCK KIT 101
7	ENCODER ECN 113
A	ENCODER ERN 180 5000 pts
B	ENCODER ECN 125
E	ENCODER ECI 4010
F	ENCODER EBI 4010
?	Contact us !

Choice depending on position feedback

B
B
B
K or P
B
B
B
B

See position feedback descriptions on page 22

## Standard possible configurations :

Shaft		Possible position feedback
Hollow shaft	1	Resolver 1 Encoder E or F
	8	Resolver 1 Encoder 2, 3, 7, A or B

# CODIFICATION FOR ST MOTORS

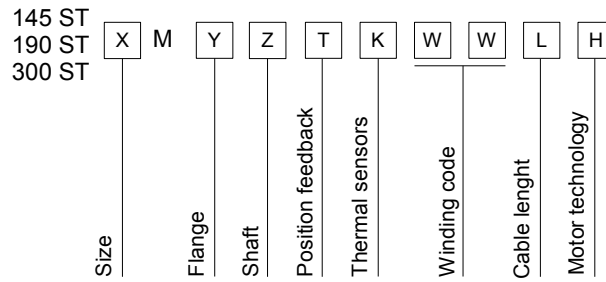

## POSITION FEEDBACK DESCRIPTION

Position feedback :

- 1 - ALXION Resolver 12 poles  $\pm 1'$  (See resolvers table)
- 2 - HEIDENHAIN® ERN180 incremental encoder 2048 sine waves 1v peak to peak  $A, \bar{A}, B, \bar{B}, C, \bar{C}$
- 3 - SICK STEGMANN® SCK KIT 101 HIPERFACE encoder
- 4 - HEIDENHAIN® ERN1387 incremental encoder 2048 sine waves 1v peak to peak  $A, \bar{A}, B, \bar{B}, C, \bar{C}$  + 2 sin waves phased of  $90^\circ$  per revolution
- 5 - HEIDENHAIN® ERN1381 incremental encoder 2048 sine waves 1v peak to peak  $A, \bar{A}, B, \bar{B}, C, \bar{C}$
- 6 - Standard resolver 2 poles  $\pm 10'$  (See resolvers table)
- 7 - HEIDENHAIN® ECN113 absolute encoder on 1 revolution, 8192 positions (13 bits), 2048 sine waves 1v peak to peak ENDAT 2.2 / 01
- 8 - HEIDENHAIN® ECN1313 absolute encoder on 1 revolution, 8192 positions (13 bits), 2048 sine waves 1v peak to peak ENDAT 2.2 / 01
- 9 - HEIDENHAIN® EQN1325 absolute encoder on 4096 revolutions (12 bits), 8192 positions per revolution (13 bits), 2048 sine waves 1v peak to peak ENDAT 2.2 / 01
- A - HEIDENHAIN® ERN180 HP incremental encoder 5000 sine waves 1v peak to peak encoder  $A, \bar{A}, B, \bar{B}, C, \bar{C}$
- B - HEIDENHAIN® ECN125 absolute encoder on 1 revolution, 33554432 positions (25 bits), ENDAT 2.2
- C - HEIDENHAIN® ECN1325 absolute on 1 revolution, 33554432 positions (25 bits), ENDAT 2.2
- D - HEIDENHAIN® EQN1337 absolute encoder on 4096 revolutions (12 bits), 33554432 positions (25 bits), ENDAT 2.2
- E - HEIDENHAIN® ECI 4010 absolute encoder on 1 revolution, 1048576 positions (20 bits), ENDAT 2.2
- F - HEIDENHAIN® EBI 4010 absolute encoder on 65536 revolutions (16 bits), 1048576 positions (20 bits), ENDAT 2.2

More information on different feedback systems on respective websites:

- <http://www.heidenhain.de>
- <http://www.sick.com>

Resolvers table

	Number of poles	Rated supply voltage (V)	Transformation ratio	Input impedance $Z_{ro}$	Output impedance $Z_{ss}$	Mechanical accuracy (arc min)	Phase shift ( $^\circ$ )
Resolver #1	12	7	0.23	$77 + j177$	$118 + j258$	$\pm 1$	7
Resolver #6	2	7	0.5	$105 + j215$	$155 + j200$	$\pm 10$	4

## THERMAL SENSORS

Our motors are equipped with two kinds of thermal sensors for winding temperature survey :

- Linear winding temperature by means of linear resistor KTY 84 : 575 Ohm at  $20^\circ\text{C}$  ; 1000 Ohm at  $100^\circ\text{C}$ .
- Winding thermal security by means of PTC resistor : ohmic value lower than 100 Ohm for acceptable temperature ; ohmic value higher than 1300 Ohm from  $160^\circ\text{C}$  threshold (maximum acceptable winding temperature)

The thermal sensors are connected to the feedback position cable for motors 145 & 190ST and to signal connector for motors 300ST.

## MOTOR TECHNOLOGY

- H : High precision technology for motor 145 & 190 ST, cogging  $< 1\%$
- S : Standard precision technology for motor 145 & 190 ST, cogging  $\leq 2\%$
- X : High precision technology for motor 300 ST, cogging  $< 2\%$

## POWER CONNECTION

Phase	145 & 190 ST Wires's mark	300ST Pin number	
		I < 25A	I ≥ 25A
U	U – 1	1	U
V	V – 2	2	V
W	W – 3	4	W
Ground	Green / Yellow	3	⊕

## POSITION FEEDBACK AND THERMAL SENSORS CONNECTIONS

Resolver (option 1 & 6*)		
Signal	145 & 190ST Wires's colors	300ST Pin number
V ref	Red	1
0V	Blue	2
Sin +	Green	3
Sin -	Yellow	4
Cos +	White	5
Cos -	Brown	6
		7
		8
KTY84	Black	9
KTY84	Violet	10
PTC	Grey	11
PTC	Pink	12

SCK KIT 101 (option 3)		
Signal	145 & 190ST Wires's colors	300ST Pin number
Us	White	1
GND	Brown	2
Sin +	Yellow	3
Sin -	Green	4
Cos +	Pink	5
Cos -	Grey	6
Data +	Blue	7
Data -	Red	8
KTY84	Grey/Pink	9
KTY84	Red/Blue	10
PTC	Black	11
PTC	Violet	12

ECN113, ECN1313*, & EQN1325* (option 7, 8* & 9*)		
Signal	145 & 190ST Wires's colors	300ST Pin number
Up	White	1
0V	Brown	2
A +	Green	3
A -	Yellow	4
B +	Grey	5
B -	Pink	6
Data +	Blue	7
Data -	Red	8
Clock +	Black	9
Clock -	Violet	10
PTC	Grey/Pink	11
PTC	Red/Blue	12
KTY84	White/Green	11
KTY84	Brown/Green	12

ERN180 (2048 & 5000 pts) & ERN1381* (option 2, A & 5*)		
Signal	145 & 190ST Wires's colors	300ST Pin number
Up	Brown	1
0V	White	2
A+	Green	3
A-	Yellow	4
B+	Grey	5
B-	Pink	6
R+	Blue	7
R-	Red	8
KTY84	Grey/Pink	9
KTY84	Red/Blue	10
PTC	Black	11
PTC	Violet	12

ECN125, ECN1325*, EQN1337*, EC4010 & EB4010 (option B, C*, D*, E & F)		
Signal	145 & 190ST Wires's colors	300ST Pin number
Up	Red	1
0V	Blue	2
Data +	Green	3
Data -	Yellow	4
Clock +	White	5
Clock -	Brown	6
		7
		8
KTY84	Black	9
KTY84	Violet	10
PTC	Grey	11
PTC	Pink	12

ERN1387* (option 4*)		
Signal	145 & 190ST Wires's colors	300ST Pin number
A+	White	Encoder Not available
A-	Brown	
R+	Green	
R-	Yellow	
D+	Pink	
D-	Grey	
C+	Blue	
C-	Red	
B+	Grey/Pink	
B-	Red/Blue	
0V	White/Green	
Up	Brown/Green	
PTC	Black	
PTC	Violet	
KTY84	White/Yellow	
KTY84	Brown/Yellow	

\* Encoder not available for 300ST motors



# RESOLVERS RES FC RANGE :

Based on the need for a maximal accuracy of the servomechanism, the resolvers developed by **ALXION** are adapted to the Motors for Direct Drive of its ST Range and can be used advantageously in axis using STK motors. They represent a further necessary step towards the exploitation of the direct drive technology.

The high accuracy resolvers with high internal hollow shaft diameter **ALXION** RES FC have been especially designed for **ALXION** Direct Drive motors. Three versions are available in 2 and 12 poles executions :

## TECHNICAL CHARACTERISTICS

### RES FC 1-72-32-90 :

- Type : transmitter 2 poles
- Frequency : 10 kHz
- Rated supplied voltage : 7 V
- Transformation ratio : 0.25
- Input impedance :  $Z_{r0} = 24 + j 233$
- Output impedance :  $Z_{ss} = 478 + j 1031$
- Accuracy : +/- 50 arc min
- Noise at null coupling : < 3/1000
- Phase shift : 1°
- Inner diameter : 90 mm

### RES FC 6-72-32-90 :

- Type : transmitter 12 poles
- Frequency : 10 kHz
- Rated supplied voltage : 7 V
- Transformation ratio : 0.23
- Input impedance :  $Z_{r0} = 77 + j 177$
- Output impedance :  $Z_{ss} = 118 + j 258$
- Accuracy : +/- 1 arc min
- Noise at null coupling : < 3/1000
- Phase shift : 7°
- Inner diameter : 90 mm

### RES FC 6-72-32-90-50 :

- Type : transmitter 12 poles
- Frequency : 10 kHz
- Rated supplied voltage : 7 V
- Transformation ratio : 0.5
- Input impedance :  $Z_{r0} = 77 + j 177$
- Output impedance :  $Z_{ss} = 396 + j 869$
- Accuracy : +/- 1 arc min
- Noise at null coupling : < 3/1000
- Phase shift : 7°
- Inner diameter : 90 mm

## RESOLVERS DIMENSIONS

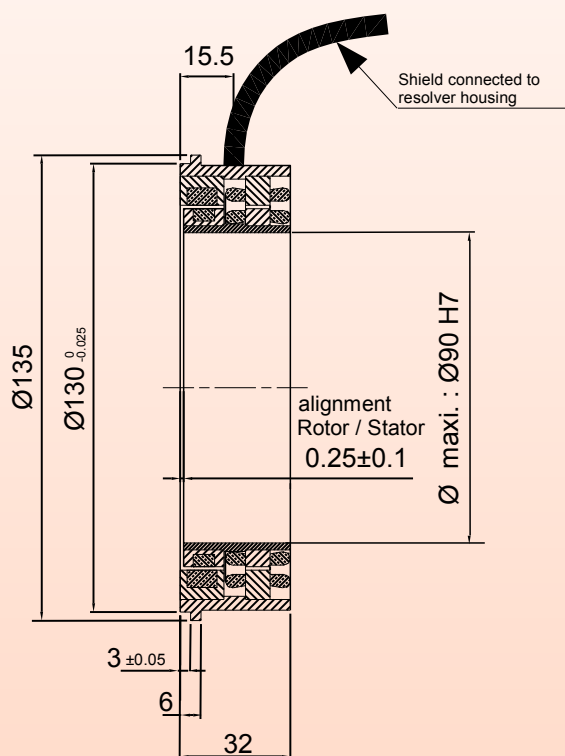

## RESOLVERS CABLING

Signal		Wire color
Sine	(S2)	Yellow
$\overline{\text{Sine}}$	(S4)	Blue
Cosine	(S1)	Red
$\overline{\text{Cosine}}$	(S3)	Black
Vref	(R1)	Red / White
$\overline{\text{Vref}}$	(R3)	Black / White

## RESOLVERS TABLE

	Codification numbers	Number of poles	Rated supply voltage (V)	Transformation ratio	Input impedance $Z_{r0}$	Output impedance $Z_{ss}$	Mechanical accuracy (arc min)	Phase shift (°)	
	FC1-72-32-90	X	2	7	0,25	24 + j 233	478 + j 1031	±50	1
	FC6-72-32-90	1	12	7	0,23	77 + j 177	118 + j 258	±1	7
	FC6-72-32-90-05	X	12	7	0,5	77 + j 177	396 + j 869	±1	7

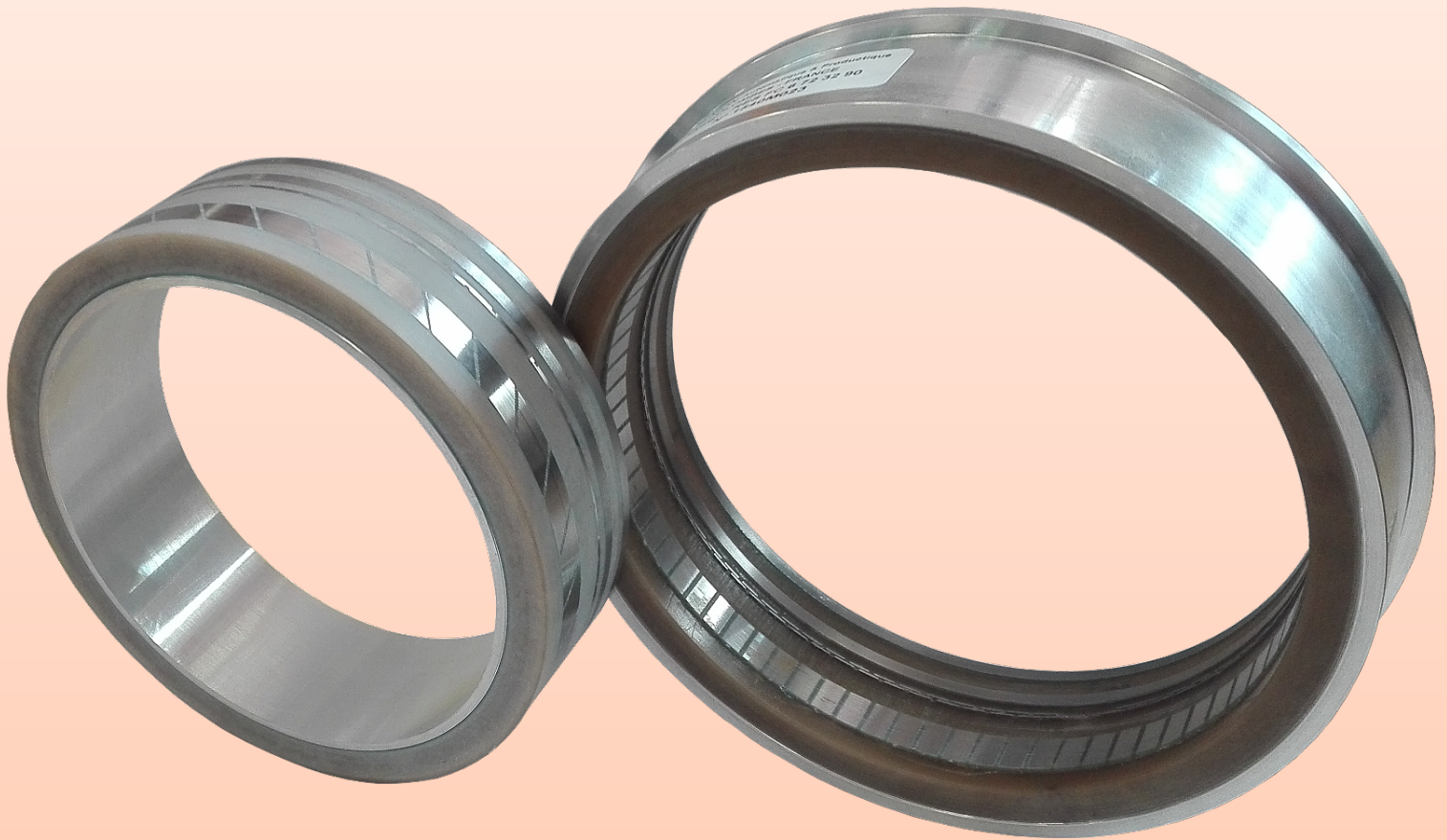

**FRAMELESS BRUSHLESS  
MOTORS  
FOR DIRECT DRIVE  
ALXION STK**

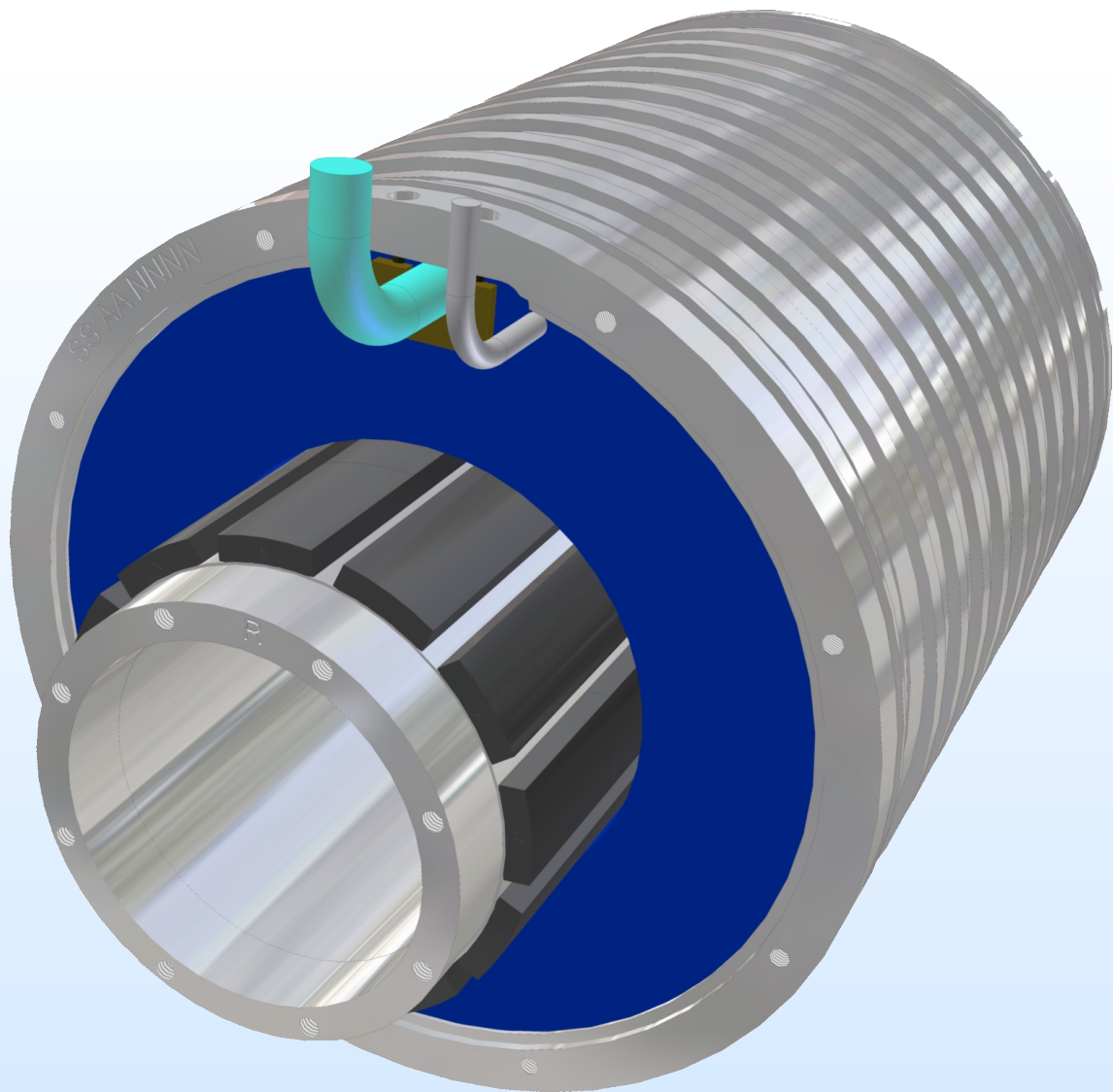

## FRAMELESS BRUSHLESS SERVOMOTORS FOR DIRECT DRIVE

### MAIN CHARACTERISTICS:

- Continuous torque from 14.6 Nm up to 2708 Nm in natural convection and up to 6100Nm in fluid cooling depending on the size.
- Six external diameters from 145 mm up to 800 mm.
- Internal diameter from 56 mm up to 630 mm.
- Various available windings from 30 rpm up to 1500 rpm depending on the size.

The range of permanent magnets brushless motors **ALXION** STK has been specially designed for the direct drive of axis without gears needing very low volume and weight regarding the torques and powers to be developed.

Therefore, both electromagnetic and thermal optimisation have allowed to reach continuous torque-to-weight up to 15 Nm / Kg in natural convection and up to 30 Nm / Kg in fluid cooling.

However, the range of frameless motors **ALXION** STK addresses very demanding industrial applications in terms of performances (dynamics, compacity, accuracy in regularity at low speed), in reliability but also in terms of costs. A particular attention has therefore been dedicated in the design so that a mixed technical and economical optimisation could be achieved.

On another hand, the industrial users can be sometimes unsatisfied by direct drive motors because they are generally torque motors getting therefore a reduced power and speed.

**ALXION** got the ambition to answer that objection with the STK range by creating motors that could satisfy the low speed applications with their related speed regularity and also to address the direct drive applications up to 30 KW in natural convection and 100 KW in fluid-cooling with speed reaching up to 1500 rpm, depending on the size.

The various speeds can be reached thanks to several windings versions. Some of them are illustrated in that catalogue but numerous winding versions allowing to optimise the drive current rating can be easily achieved.

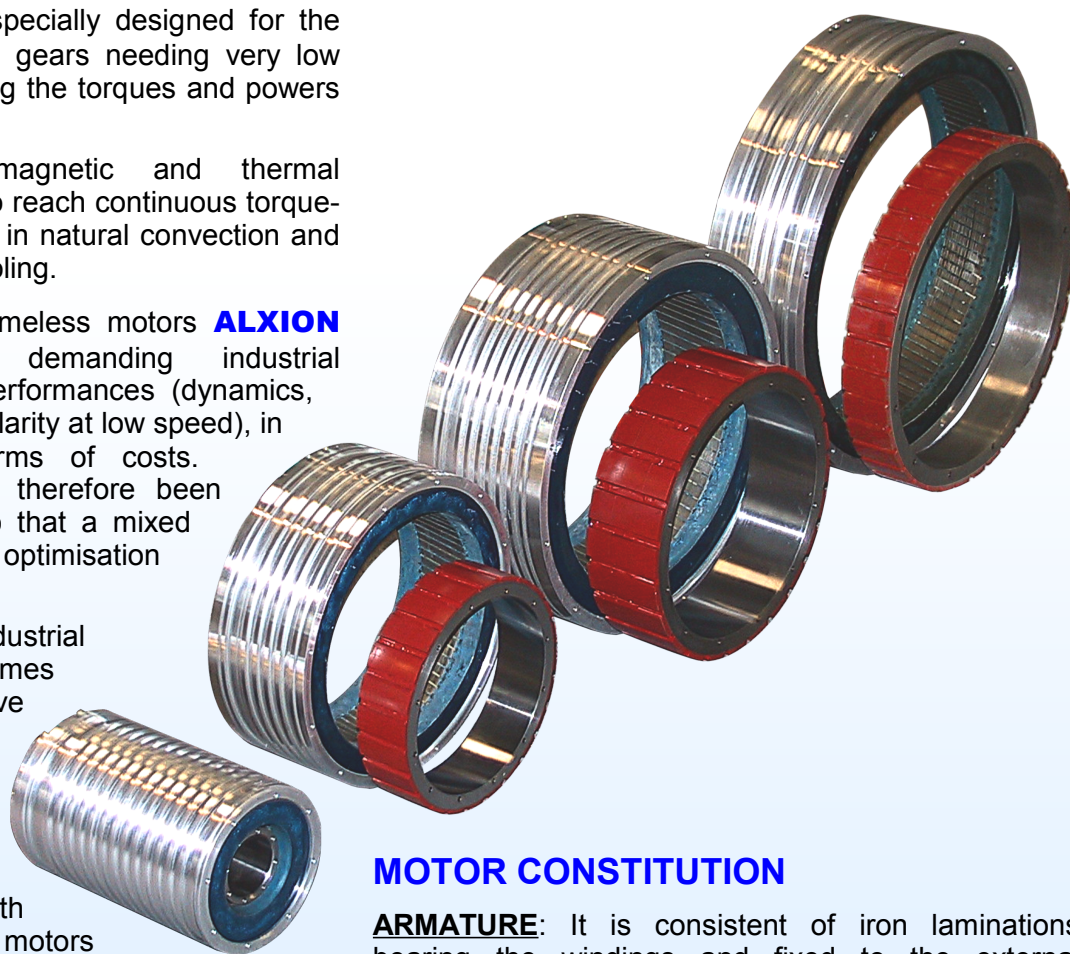

### MOTOR CONSTITUTION

**ARMATURE:** It is consistent of iron laminations bearing the windings and fixed to the external housing. The windings are encapsulated in resin. Housing is either smooth either grinded for bearing the engravement of the cooling circuit when it is requested.

- Winding in H class.
- Output cable class 6 with 4 shielded wires for the power.
- Thermal protection by PTC resistor and linear resistor KTY84 embedded in the winding. Output cable class 6 with 2 shielded pairs.

**ROTOR:** Rare earth magnets protected against corrosion are stuck around a magnetic iron ring.

For all detailed specifications related to integration and environment, please ask for our « handbooks for integration »

## STATOR AND ROTOR MOUNTING

Optionally STK armatures and rotors can be shipped mounted on a centering and positioning flange for avoiding the user to make the operation of mounting and centering the rotor inside the stator.

## OPERATION IN NATURAL CONVECTION

The armature is the source of both current losses and hysteretic and eddy current losses. It will be necessary to take it into account for integrating the motor. Here are the main elements to be taken in consideration:

- Permanent torques of the motors are indicated for a copper temperature rise of 120°C for armatures in contact with ambient air or integral on all their peripheral area with a metallic part in contact with ambient air. In addition, the motor housing has to be fixed on a metallic flange with an area equal to at least twice its section.

For example, for a 400 mm diameter motor, the flange will have an area equal to:  $2 \cdot \frac{\pi \cdot 0.4^2}{4}$  i.e. 0.25m<sup>2</sup>

- Avoid any enclosed environment or if it is necessary consult us for knowing the motor derating.
- Be sure that the materials located in the motor vicinity can bear high temperatures or if it is not the case consult us for knowing the motor derating.

## FLUID COOLING

For avoiding to be dependent from environment problems related to overheating or in the case when continuous torques higher than those got in natural convection are needed, a fluid cooling will be used.

Two operating points are characterised in fluid cooling:

- Winding at 60°C.
- Maximum cooling (winding at 140°C) for getting the maximum continuous torque of the motor.



Use glycoled softened water or a fluid approved for closed cooling circuit in order to minimise the risks of corrosion and deposits.

The housing engravement is consistent of 2 extremity grooves for O - ring, then two circular grooves allowing the input and the output of the fluid separated by the cooling circuit.

When mounting the device, the input and output pipes will be axially aligned at the opposite of the input and the output of the cooling circuit.

## DRIVES AND ASSOCIATED POSITION SENSORS

The frameless motors **ALXION** STK have been designed for minimising the torque harmonics when they are fed by sinusoidal wave drives for brushless motors.

The STK motors are therefore compatible with a wide spectrum of brushless drives available on the market and namely with the ranges of single axis digital drives MOOG, DBS and DS 2000 and multiaxis DBM, SIEMENS 611D with AN power supply, NUM Schneider MDLU, Parker COMPAX, GE FANUC, CONTROL-TECHNIQUES UNIDRIVE, B & R, DANAHER Servostar 600, ...

However, in the aim of maximising the servo performances, we do recommend to use drives including the following features:

- Digital current loop with programmable gains or self adaptative gains.
- Built-in anti-resonant programmable filters on the speed error in order to maintain high servo gains in the case when the load inertia is very high related to the rotor inertia.

· Various positioning sensor interfaces: the drives can be compatible with 4 kinds of positioning interfaces:

- Resolver:

The resolvers are in the best cases (**ALXION** resolver RES FC6 72 32) limited to an accuracy of 1 arc minute. In most of the resolvers available on the market, accuracy is rather around several minutes.

It will be necessary to check whether the desired positioning accuracy is compatible with the resolver accuracy and also the electronic resolver-to-digital circuit.

On another hand, the resolvers limit the applications due to the crossing hollow shaft. The resolvers **ALXION** RES FC6 72 32 allow a hollow shaft up to 90 mm.

Finally, the resolvers allow to get a resolution up to several hundred thousands of points per revolution but such a high resolution is not useful because it is not compatible with the accuracy of the measurement system.

- TTL encoder or TTL optical scale:

The TTL encoders have generally a limited number of cpr (from 500 up to 5000). One can find some encoders with hollow shaft up to 50 mm internal diameter and with a number of cpr between 15000 and 20000 (to be multiplied by 4).

The best solution in terms of resolution and accuracy consists in the optical scales with pitches from 0.5 to 5  $\mu$  that can be stuck on a hollow hub with appropriate diameter. They can allow a resolution equal to 1 million cpr or much more according to the diameter.

The associated read heads are characterised by a maximum frequency limiting so the speed for a given resolution.

- Sin / cos encoder or sin /cos scales:

These encoders or scales are the most widely used.

The same limitations as previously mentioned exist on these devices. However, the advantage of this technology consists in the possibility to multiply the sine wave signals of these encoders thanks to appropriate drive interfaces. Thus, an encoder with 1024 sine waves per resolution will allow with multiplication per 1000 to get one million cpr. The sin / cos optical scale gets the advantage to allow both high resolution either naturally either by internal drive interpolation and a crossing hollow shaft without any limitation thanks to its sticking on an appropriate diameter hub. Some encoder suppliers integrate in their catalogue optical scales mounted on hubs with various diameters. Some bearing manufacturers integrate sine wave measuring scales in the bearings.

- Absolute encoders:

The absolute encoders allow to get the characteristics described for the TTL or Sin-Cos encoders without the need of starting sequence for phase commutation (see following paragraph). They do not need a homing phase for the axis origin.

## PHASES COMMUTATION

The permanent magnets synchronous motors need a constant phase between the armature and the rotor rotating fields in order to control the torque. The resolver allows this phasing and gives simultaneously the axis position (on one polar pitch). The absolute encoders allow also that phasing. It is not the case with incremental encoders or scales.

The encoder suppliers have therefore specific ranges for brushless motors including either:

- a) Three phase commutation rectangular signals  $U, V, W, \bar{U}, \bar{V}, \bar{W}$  in the case of TTL encoders ; but these waveforms should have the same number of periods per revolution than the motor (polarity).
- b) Sine waves signals (1 period per revolution) sine and cosine giving the absolute position on a revolution in the case of sin / cos encoders. The drive electronic interface multiplies that frequency by the number of the motor pole pairs.

In the case of optical scales mounted on hubs, the information related to the phasing between the armature and the rotor fields is not known. Therefore an initialisation sequence is needed during start-up ; during that sequence the rotor will operate an indexing motion or at least a microvibration.

## Natural convection

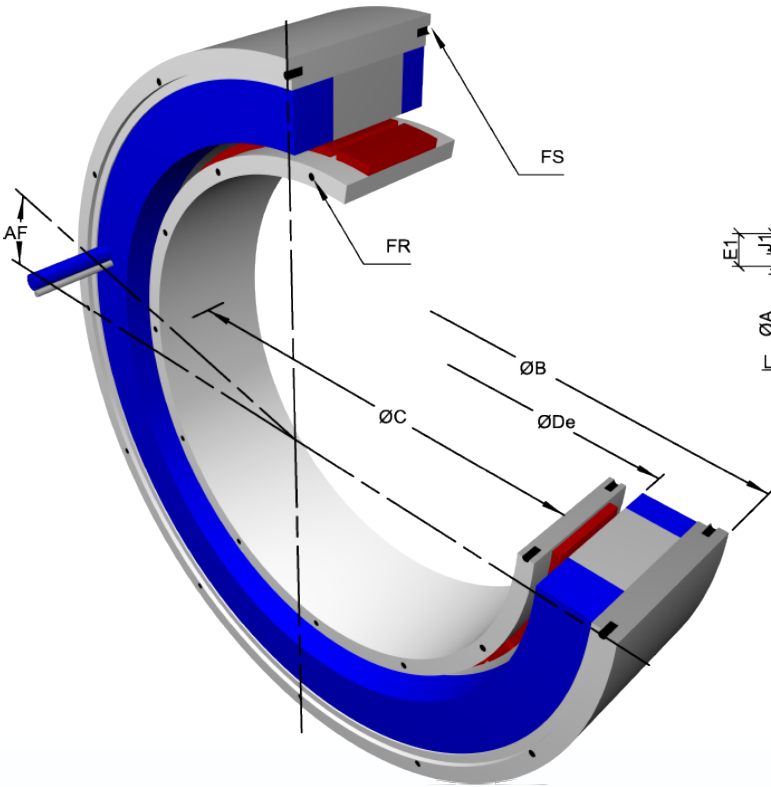

## Fluid cooling

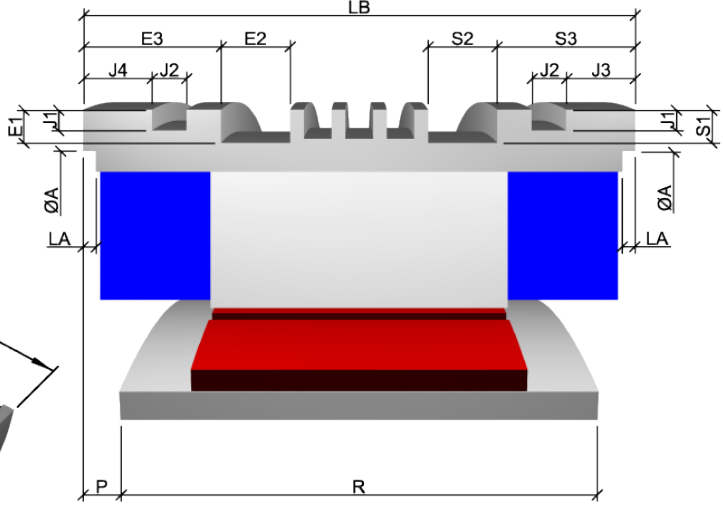

DIMENSIONS FOR ALL 145 STK		
Housing internal centering diameter	A H8	130
Angle wire output / tapped holes	AF	22°30'
Housing external centering diameter (fluid cooling)	B f8	153
Housing external centering diameter (natural convection)	B f8	145
Rotoric internal centering diameter	C H7	56
Housing internal diameter	De	78.5
Depth of fluid front input / output groove	E1	4
Width of fluid front input / output groove	E2	13.35
Position of fluid front I/O groove	E3	16.3
Rotoric fixation holes	FR	8xM5 sur Ø63
Housing fixation holes	FS	8xM5 sur Ø136
O-ring groove depth	J1	2.3
O-ring groove width	J2	4
Position of rear o-ring groove	J3	3
Position of front o-ring groove	J4	10.8
Depth of housing internal centering diameter	LA	2
Alignment rotor / housing	P ± 0.1	20.5
Maximum rotoric contact diameter	Pmax	75
Depth of fluid rear I/O groove	S1	4
Width of fluid rear I/O groove	S2	13.35
Position of fluid rear I/O groove	S3	8.5

## DIMENSIONS ACCORDING TO SIZE

	145STK1M	145STK2M	145STK3M	145STK4M	145STK5M	145STK6M	145STK7M	145STK8M	
Housing length	LB±0.15	92	119	146	173	200	227	254	281
Rotor length	R +0.15	59	86	113	140	167	194	221	248

### INTEGRATION:

- ✓ The cables are made of PU, class 6, foreseen for cable-bearing chains, 2 mt standard length, copper square section according rated current.
- ✓ Rotor / housing alignment (P) has to be executed within +/- 0.1 mm. Optionally, we can supply a mounting tool for achieving that alignment in case of assembly without possibility of accurate alignment.
- ✓ Thermal devices cable consists of 2 shielded pairs 2x2x0.25mm<sup>2</sup> section, 7 mm max external diameter.
- ✓ (De) represents:
  - 1- The maximum diameter passing inside the housing.
  - 2- The minimum diameter necessary for rotor assembly.
- ✓ (Pmax) diameter for pieces in contact with the rotor must never be exceeded.
- ✓ Tapped holes on each side of rotor and housing are angularly aligned.
- ✓ Cable positioning (AF) is theoretical. Leave a free room with a +/- 10 arc degrees tolerance around that position, on a 50 mm height from the housing side, for avoiding to stress the cables at the motor output.  
Do not tighten, twist or bend the power cable on the first 50 mm from motor side. Clamp the cable after those 50 mm.
- ✓ When designing the assembly, take care to insure a perfect contact between housing and user's bore for avoiding thermal problems.
- ✓ For housing mounting, use either external centering diameter (B) or internal centering diameters (A).
- ✓ For execution tolerances (perpendicularity, concentricity...), please consult us.
- ✓ Fluid input and output pipes have to be placed at the opposite of wire outputs on the same axial plane.
- ✓ O-ring grooves designed for 3 mm diameter o-rings.

A full integration handbook can be supplied to our customers upon request  
For further information or specific request about our motors, feel free to contact us.

# TECHNICAL CHARACTERISTICS

Windings for 400V / 460Vac drives (See Application note)

			145STK1M		145STK2M		145STK3M		145STK4M		145STK6M		145STK8M	
NATURAL CONVECTION	Rated speed	rpm	500	1500	500	1500	500	1500	500	1500	500	1500	500	1500
	Continuous torque at stall (1)(4)	N.m	8		14.6		20.5		26.4		37.3		47.4	
	Current at continuous torque (1)	A	1.6	2.9	2.3	5.2	2.9	6.7	3.7	9.2	5	12.7	6.4	15.7
	Peak torque (2)(3)	N.m	27.5		55		83		110		165		220	
	Current at peak torque (2)	A	6.9	11.1	10.2	23.1	14.9	34.2	17.8	45.5	27.3	68.3	35.6	91.1
	Rated power (1)	W	390	866	710	1850	992	2504	1260	3080	1770	3830	2230	4580
	Inertia	10 <sup>-3</sup> kg.m <sup>2</sup>	0.80		1.28		1.76		2.24		3.19		4.14	
	Weight	kg	4.1		6.2		8.5		10.4		14.5		18.7	
	Thermal time constant (1)	s	850		1012		1206		1399		1667		1866	
	Thermal resistance (1)	°C / W	0.447		0.394		0.36		0.324		0.275		0.239	
	Phase resistance at 20°C (2)	Ω	21.6	7.9	12.9	2.55	7.52	1.43	6.2	0.95	3.46	0.55	2.51	0.38
	Phase inductance at I continuous	mH	72	25.8	66.7	12.4	47.8	9.1	44.5	6.8	28.2	4.5	22.2	3.4
	Electrical time constant (2)	ms	3.4		5.1		6.4		7.2		8.2		8.9	
	Back emf constant (line to line) (2)	V/rad.s	3.13	1.86	4.25	1.91	4.38	1.91	4.88	1.91	4.78	1.91	4.88	1.91
	Power cable square section	nxmm <sup>2</sup>	4x1.5		4x1.5		4x1.5		4x1.5		4x1.5		4x1.5	
Power cable diameter	mm	Ø8.6		Ø8.6		Ø8.6		Ø8.6		Ø8.6		Ø8.6		
Number of poles		12												

			145STK1M		145STK2M		145STK3M		145STK4M		145STK6M		145STK8M	
COMPLEMENTARY DATA FOR FLUID-COOLED MOTORS WINDING AT 60°C	Continuous torque at stall (4)	N.m	11		22.8		33.8		45.3		67.6		90	
	Current at continuous torque	A	2.4	4	3.5	8	5.2	12	6.3	15.6	9	22.8	12.1	29.8
	Fluid input temperature (5)(6)	°C	20		20		20		20		20		20	
	Fluid temperature rise	°C	3		5		4		5		7		8	
	Housing temperature	°C	< 30		< 30		< 30		< 30		< 30		< 30	
	Fluid flow	l / mn	2		3		3		3		3		3	
	Losses	W	490		620		780		930		1220		1510	
	Pressure drop	Bar	0.1		0.2		0.2		0.3		0.4		0.5	
	Power cable square section	nxmm <sup>2</sup>	4x1.5		4x1.5		4x1.5		4x1.5		4x1.5		4x4	
	Power cable diameter	mm	Ø8.6		Ø8.6		Ø8.6		Ø8.6		Ø8.6		Ø12.2	

			145STK1M		145STK2M		145STK3M		145STK4M		145STK6M		145STK8M	
COMPLEMENTARY DATA FOR FLUID-COOLED MOTORS WINDING AT 140°C	Continuous torque at stall (4)	N.m	15		29.9		46		59.8		90		120	
	Current at continuous torque	A	3.4	5.7	5.4	12.3	7.5	17.1	9.7	24	14	35.5	19	46.8
	Fluid input temperature (5)(6)	°C	20		20		20		20		20		20	
	Fluid temperature rise	°C	5		8		8		8		10		12	
	Housing temperature	°C	< 30		33		< 30		< 30		< 30		31	
	Fluid flow	l / mn	4		3		4		5		5		5	
	Losses	W	1187		1532		1855		2240		2950		3660	
	Pressure drop	Bar	0.2		0.2		0.4		0.7		1		1.3	
	Power cable square section	nxmm <sup>2</sup>	4x1.5		4x1.5		4x1.5		4x2.5		4x1.5		4x6	
	Power cable diameter	mm	Ø8.6		Ø8.6		Ø8.6		Ø10.8		Ø8.6		Ø14	

- Thermal conditions:  
Ambient temperature 20°C  
Winding temperature rise 120°C  
Stator housing in contact with the ambient air or integral on all its peripheral area with a metallic armature in contact with the ambient air.  
Stator housing secured on a metallic frame having an area equal to twice the cross section of the housing.
- Cold motor at 20°C
- See torque vs speed characteristics on :  
<http://www.alxion.com/>
- Torque at stall or low speed.
- Fluid input temperature should not be lower for avoiding condensation inside the motor.
- For cooling fluid, use softened glycol-added water or fluids approved for closed cooling circuits.

Other speed characteristics are available, please contact us.



# TORQUE VS SPEED CURVES MOTORS 145STK

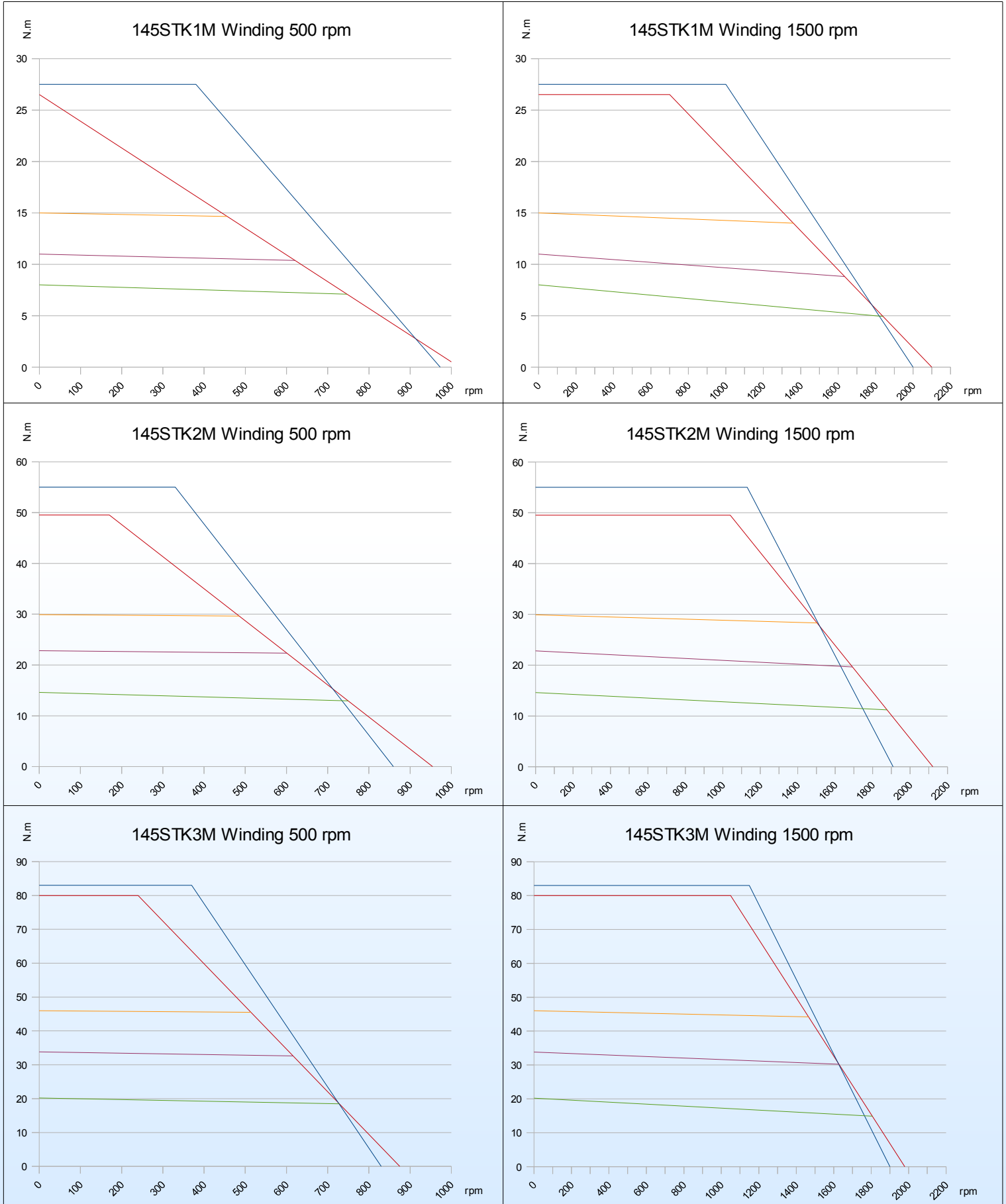

- Continuous torque with natural convection
- Continuous torque liquid cooled winding at 60°C
- Continuous torque liquid cooled winding at 140°C
- Max. transient characteristics motor at 20°C 400VAC mains / 540VDC bus with flux vector control
- Max. transient characteristics motor at rated temp 400VAC mains / 540VDC bus with flux vector control

Other windings can be supplied for matching your needs ; please contact us.

# TORQUE VS SPEED CURVES MOTORS 145STK

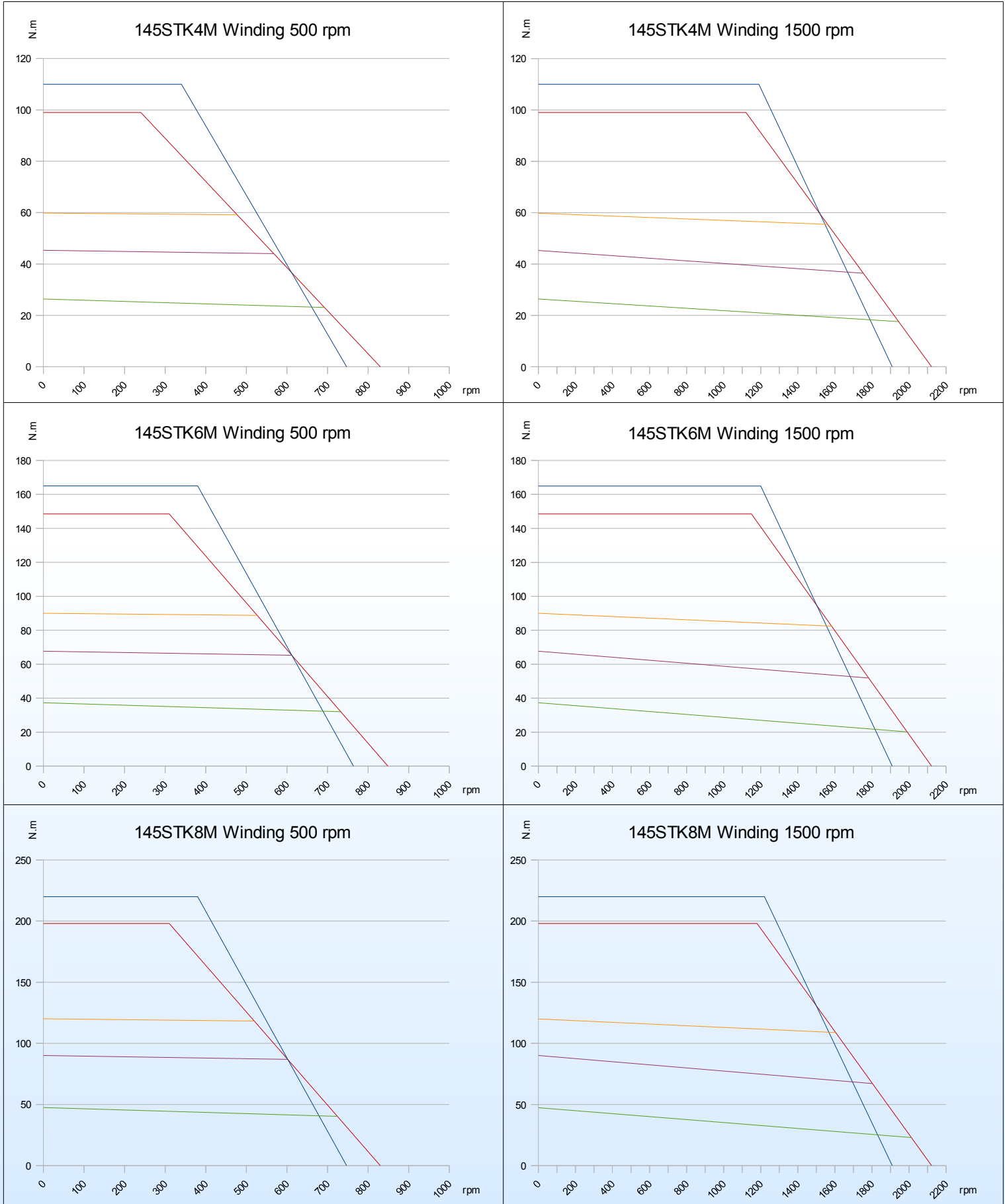

- Continuous torque with natural convection
- Continuous torque liquid cooled winding at 60°C
- Continuous torque liquid cooled winding at 140°C
- Max. transient characteristics motor at 20°C 400VAC mains / 540VDC bus with flux vector control
- Max. transient characteristics motor at rated temp 400VAC mains / 540VDC bus with flux vector control

Other windings can be supplied for matching your needs ; please contact us.

## Natural convection

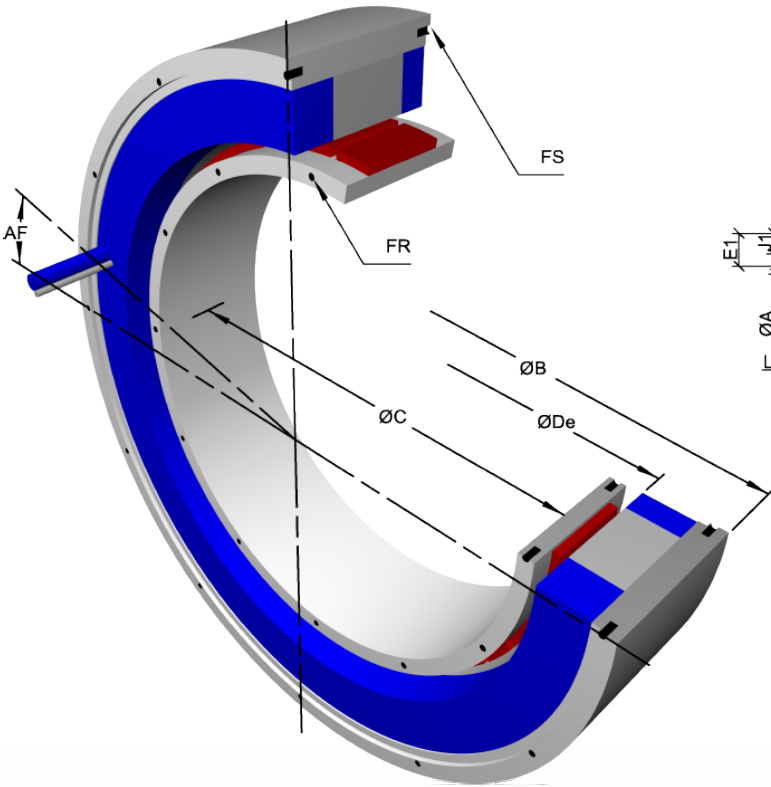

## Fluid cooling

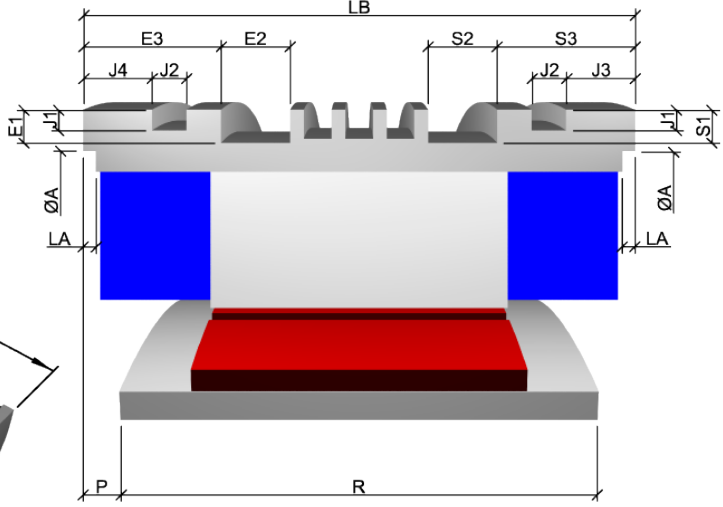

**DIMENSIONS FOR ALL 190 STK**

Housing internal centering diameter	A H8	172
Angle wire output / tapped holes	AF	22°30'
Housing external centering diameter (fluid cooling)	B f8	193
Housing external centering diameter (natural convection)	B f8	190
Rotoric internal centering diameter	C H7	72
Housing internal diameter	De	98
Depth of fluid front input / output groove	E1	3
Width of fluid front input / output groove	E2	11.7
Position of fluid front I/O groove	E3	15.5 (45.5)
Rotoric fixation holes	FR	8xM5 sur Ø80
Housing fixation holes	FS	8xM5 sur Ø180
O-ring groove depth	J1	2.3
O-ring groove width	J2	4
Position of rear o-ring groove	J3	5
Position of front o-ring groove	J4	10 (40)
Depth of housing internal centering diameter	LA	2
Alignment rotor / housing	P ± 0.1	23 (53)
Maximum rotoric contact diameter	Pmax	94
Depth of fluid rear I/O groove	S1	3
Width of fluid rear I/O groove	S2	11.7
Position of fluid rear I/O groove	S3	10.5

**DIMENSIONS ACCORDING TO SIZE**

		190S TK1M	190S TK2M	190S TK3M	190S TK4M	190S TK5M	190S TK6M	190S TK7M	190S TK8M
Housing length	LB ± 0.15	103.75 (133.75)	140 (175)	176.25 (206.25)	212.5 (242.5)	248.75 (278.75)	285 (315)	321.25 (351.25)	357.5 (387.5)
Rotor length	R + 0.15	68.25	104.5	140.75	177	213.25	249.5	285.75	322

The dimensions in red in the table are valid in the case of a rated current greater than 53 A and class 6 shielded cable output

We also offer the possibility of not shielded output wires without need of stator length increase.

**INTEGRATION:**

- ✓ The cables are made of PU, class 6, foreseen for cable-bearing chains, 2 mt standard length, copper square section according rated current.
- ✓ Rotor / housing alignment (P) has to be executed within +/- 0.1 mm. Optionally, we can supply a mounting tool for achieving that alignment in case of assembly without possibility of accurate alignment.
- ✓ Thermal devices cable consists of 2 shielded pairs 2x2x0.25mm<sup>2</sup> section, 7 mm max external diameter.
- ✓ (De) represents:
  - 1- The maximum diameter passing inside the housing.
  - 2- The minimum diameter necessary for rotor assembly.
- ✓ (Pmax) diameter for pieces in contact with the rotor must never be exceeded.
- ✓ Tapped holes on each side of rotor and housing are angularly aligned.
- ✓ Cable positioning (AF) is theoretical. Leave a free room with a +/- 10 arc degrees tolerance around that position, on a 50 mm height from the housing side, for avoiding to stress the cables at the motor output.
- Do not tighten, twist or bend the power cable on the first 50 mm from motor side. Clamp the power cable after those 50 mm.
- ✓ When designing the assembly, take care to insure a perfect contact between housing and user's bore for avoiding thermal problems.
- ✓ For housing mounting, use either external centering diameter (B) or internal centering diameters (A).
- ✓ For execution tolerances (perpendicularity, concentricity...), please consult us.
- ✓ Fluid input and output pipes have to be placed at the opposite of wire outputs on the same axial plane.
- ✓ O-ring grooves designed for 3 mm diameter o-rings.

A full integration handbook can be supplied to our customers upon request  
 For further information or specific request about our motors, feel free to contact us.

# TECHNICAL CHARACTERISTICS

## Windings for 400V / 460Vac drives (See Application note)

			190STK1M		190STK2M		190STK3M		190STK4M		190STK6M		190STK8M	
NATURAL CONVECTION	Rated speed	rpm	500	1500	500	1500	500	1500	500	1500	500	1000	500	1000
	Continuous torque at stall (1)(4)	N.m	19		36		49		63		89		111	
	Current at continuous torque (1)	A	3	6.5	4.5	11.7	5.9	13.2	7.1	19.3	11.1	20	13.3	23.3
	Peak torque (2)(3)	N.m	62		124		186		248		372		496	
	Current at peak torque (2)	A	11.8	25.6	18.6	48.9	27	60.3	34.2	93.2	56.9	102.5	73.2	128.1
	Rated power (1)	W	910	2560	1730	4230	2360	5259	3024	6590	4250	7085	5250	8530
	Inertia	10 <sup>-3</sup> kg.m <sup>2</sup>	2.4		4.12		5.8		7.5		10.88		14.26	
	Weight	kg	8.5		13		17.5		22		31		40	
	Thermal time constant (1)	s	1200		1506		1850		2129		2559		2865	
	Thermal resistance (1)	°C / W	0.28		0.25		0.23		0.2		0.17		0.15	
	Phase resistance at 20°C (2)	Ω	9.45	2	4.76	0.69	2.76	0.56	2.12	0.28	1.02	0.31	0.77	0.25
	Phase inductance at I continuous	mH	55.2	11.8	48.2	7	31.7	6.4	28.8	3.9	15.7	4.8	12.7	4.1
	Electrical time constant (2)	ms	5.9		10.1		11.5		13.6		15.6		16.5	
	Back emf constant (line to line) (2)	V/rad.s	4.06	1.87	5.13	1.96	5.32	2.38	5.6	2.05	5.04	2.8	5.22	2.99
	Power cable square section (7)	nxmm <sup>2</sup>	4x1.5		4x1.5		4x1.5		4x1.5		4x2.5		4x4	
Power cable diameter (7)	mm	Ø8.6		Ø8.6		Ø8.6		Ø8.6		Ø10.8		Ø12.2		
Number of poles		12												

			190STK1M		190STK2M		190STK3M		190STK4M		190STK6M		190STK8M	
COMPLEMENTARY DATA FOR FLUID-COOLED MOTORS WINDING AT 60°C	Continuous torque at stall (4)	N.m	26.6		57		84		109		162		209	
	Current at continuous torque	A	4.3	9.4	7.5	19.6	10.4	23.2	13	35.5	21.3	38.4	26.6	46.2
	Fluid input temperature (5)(6)	°C	20		20		20		20		20		20	
	Fluid temperature rise	°C	5		6		7		7		8		10	
	Housing temperature	°C	< 30		< 30		< 30		< 30		< 30		< 30	
	Fluid flow	l / mn	2		3		3		4		4		4	
	Losses	W	650		995		1110		1330		1710		1980	
	Pressure drop	Bar	< 0.1		0.12		0.12		0.3		0.5		0.6	
	Power cable square section (7)	nxmm <sup>2</sup>	4x1.5		4x1.5		4x2.5		4x4		4x6		4x10	
	Power cable diameter (7)	mm	Ø8.6		Ø8.6		Ø10.8		Ø8.6		Ø12.2		Ø17.6	

			190STK1M		190STK2M		190STK3M		190STK4M		190STK6M		190STK8M	
COMPLEMENTARY DATA FOR FLUID-COOLED MOTORS WINDING AT 140°C	Continuous torque at stall (4)	N.m	36.3		71.4		106		141		210		274	
	Current at continuous torque	A	6.1	13.2	9.5	24.8	13.5	30.2	17.3	47.2	29.3	52.7	36	63
	Fluid input temperature (5)(6)	°C	20		20		20		20		20		20	
	Fluid temperature rise	°C	5		6		7		7		8		10	
	Housing temperature	°C	< 30		< 30		< 30		< 30		< 30		< 30	
	Fluid flow	l / mn	4		6		6		7		9		8	
	Losses	W	1533		1900		2290		2800		3850		4390	
	Pressure drop	Bar	0.1		0.4		0.6		0.85		1.8		1.9	
	Power cable square section (7)	nxmm <sup>2</sup>	4x1.5		4x1.5		4x4		4x6		4x2.5		4x10	
	Power cable diameter (7)	mm	Ø8.6		Ø8.6		Ø12.2		Ø8.6		Ø14		Ø10.8	

- (1) Thermal conditions:  
Ambient temperature 20°C  
Winding temperature rise 120°C  
Stator housing in contact with the ambient air or integral on all its peripheral area with a metallic armature in contact with the ambient air.  
Stator housing secured on a metallic frame having an area equal to twice the cross section of the housing.
- (2) Cold motor at 20°C
- (3) See torque vs speed characteristics on :  
<http://www.alxion.com/>
- (4) Torque at stall or low speed.
- (5) Fluid input temperature should not be lower for avoiding condensation inside the motor.
- (6) For cooling fluid, use softened glycol-added water or fluids approved for closed cooling circuits.
- (7) For currents lower than 53 Amps, one shielded cable  
For currents over 53 Amps, four single shielded wires output (highlighted in the table)

Other speed characteristics are available, please contact us.

# TORQUE VS SPEED CURVES MOTORS 190STK

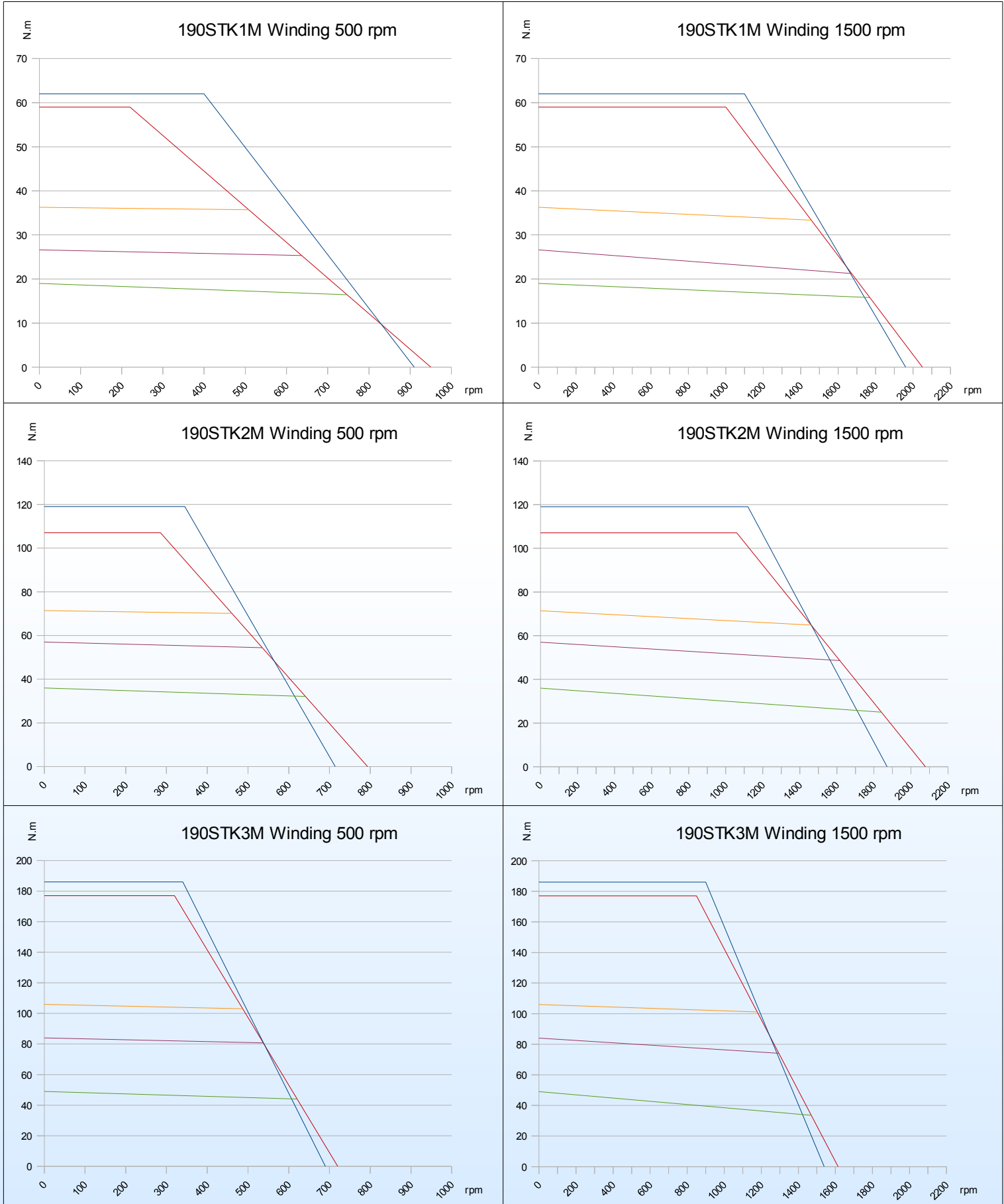

- Continuous torque with natural convection
- Continuous torque liquid cooled winding at 60°C
- Continuous torque liquid cooled winding at 140°C
- Max. transient characteristics motor at 20°C 400VAC mains / 540VDC bus with flux vector control
- Max. transient characteristics motor at rated temp 400VAC mains / 540VDC bus with flux vector control

Other windings can be supplied for matching your needs ; please contact us.

# TORQUE VS SPEED CURVES MOTORS 190STK

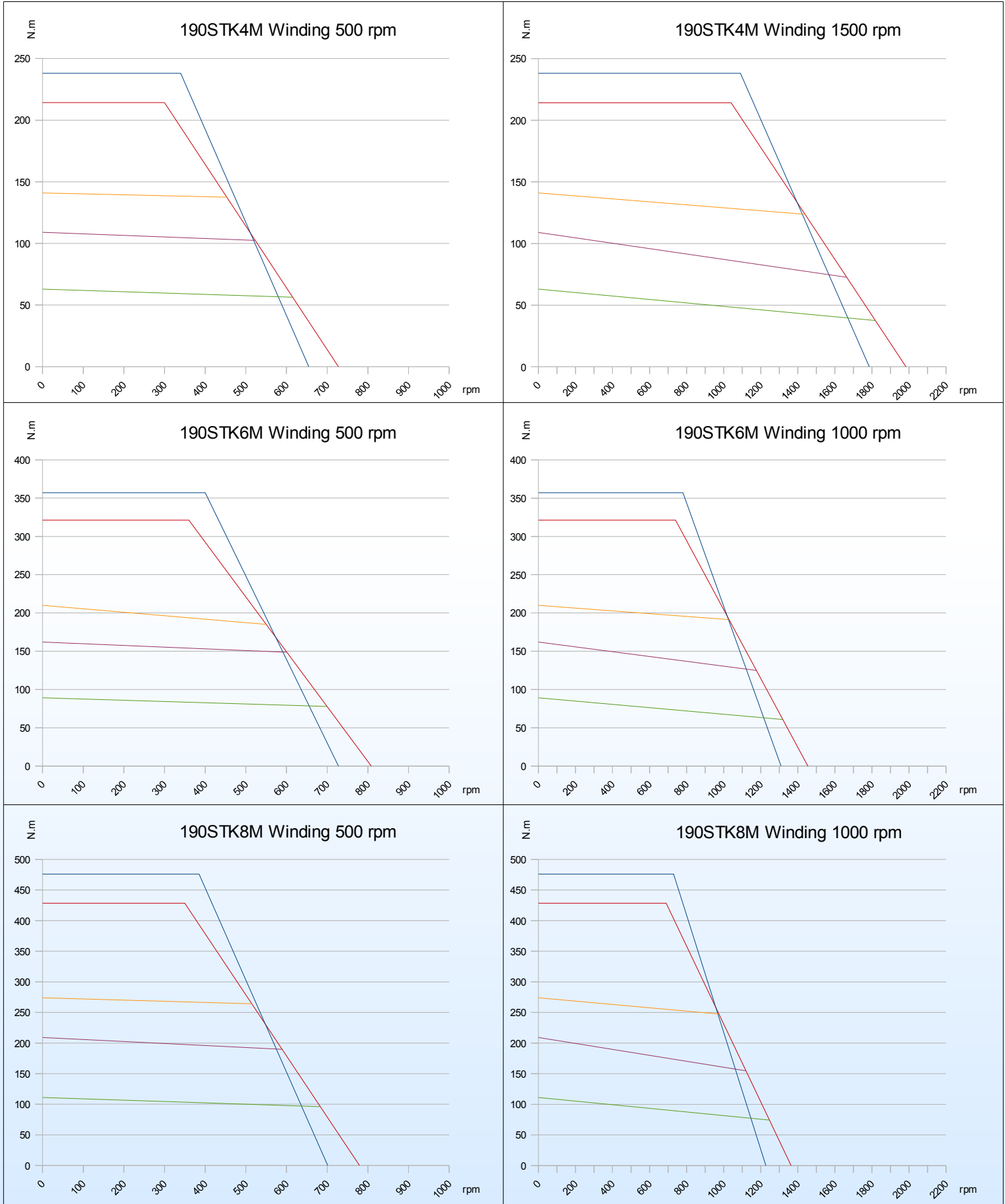

- Continuous torque with natural convection
- Continuous torque liquid cooled winding at 60°C
- Continuous torque liquid cooled winding at 140°C
- Max. transient characteristics motor at 20°C 400VAC mains / 540VDC bus with flux vector control
- Max. transient characteristics motor at rated temp 400VAC mains / 540VDC bus with flux vector control

Other windings can be supplied for matching your needs ; please contact us.

## Natural convection

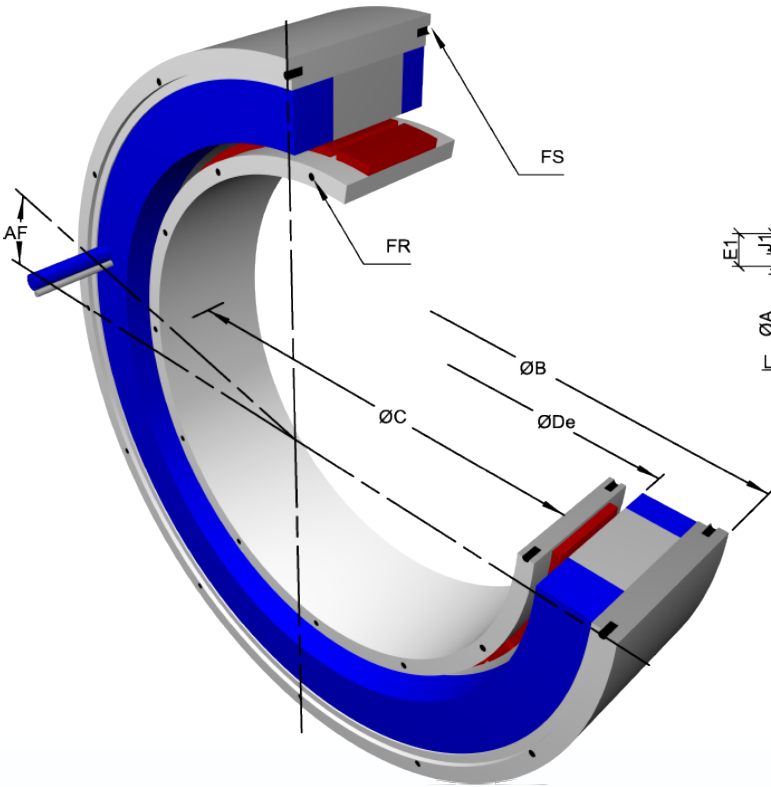

## Fluid cooling

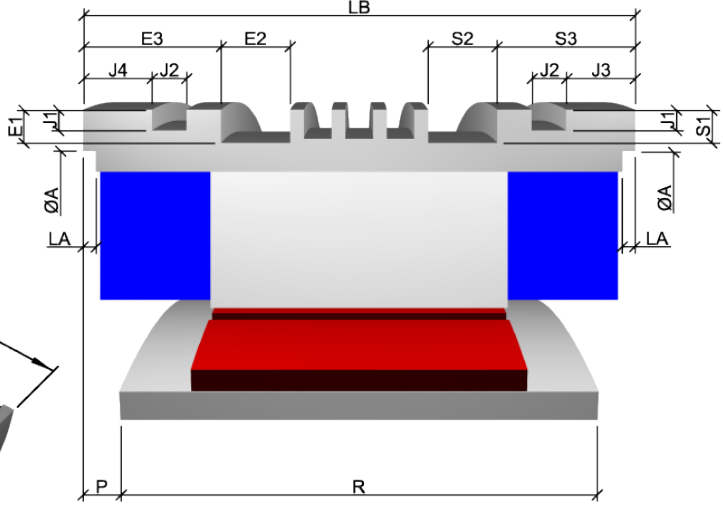

DIMENSIONS FOR ALL 300 STK		
Housing internal centering diameter	A H8	282
Angle wire output / tapped holes	AF	15°
Housing external centering diameter (fluid cooling)	B f8	303
Housing external centering diameter (natural convection)	B f8	303
Rotoric internal centering diameter	C H7	190
Housing internal diameter	De	228
Depth of fluid front input / output groove	E1	4
Width of fluid front input / output groove	E2	12
Position of fluid front I/O groove	E3	20 (50)
Rotoric fixation holes	FR	12xM5 sur Ø199
Housing fixation holes	FS	12xM5 sur Ø290
O-ring groove depth	J1	2.3
O-ring groove width	J2	4
Position of rear o-ring groove	J3	9
Position of front o-ring groove	J4	11.5 (41.5)
Depth of housing internal centering diameter	LA	3
Alignment rotor / housing	P ± 0.1	34.5 (64.5)
Maximum rotoric contact diameter	Pmax	213
Depth of fluid rear I/O groove	S1	4
Width of fluid rear I/O groove	S2	10
Position of fluid rear I/O groove	S3	18

## DIMENSIONS ACCORDING TO SIZE

		300S TK1M	300S TK2M	300S TK3M	300S TK4M	300S TK5M	300S TK6M	300S TK7M	300S TK8M
Housing length	LB ± 0.15	87.5 (117.5)	115 (145)	142.5 (172.5)	170 (200)	197.5 (227.5)	225 (255)	252.5 (282.5)	280 (310)
Rotor length	R + 0.15	27.5	55	82.5	110	137.5	165	192.5	220

The dimensions in red in the table are valid in the case of a rated current greater than 38 A and class 6 shielded cable output

We also offer the possibility of not shielded output wires without need of stator length increase.

### INTEGRATION:

- ✓ The cables are made of PU, class 6, foreseen for cable-bearing chains, 2 mt standard length, copper square section according rated current.
- ✓ Rotor / housing alignment (P) has to be executed within +/- 0.1 mm. Optionally, we can supply a mounting tool for achieving that alignment in case of assembly without possibility of accurate alignment.
- ✓ Thermal devices cable consists of 2 shielded pairs 2x2x0.25mm<sup>2</sup> section, 7 mm max external diameter.
- ✓ (De) represents:
  - 1- The maximum diameter passing inside the housing.
  - 2- The minimum diameter necessary for rotor assembly.
- ✓ (Pmax) diameter for pieces in contact with the rotor must never be exceeded.
- ✓ Tapped holes on each side of rotor and housing are angularly aligned.
- ✓ Cable positioning (AF) is theoretical. Leave a free room with a +/- 10 arc degrees tolerance around that position, on a 50 mm height from the housing side, for avoiding to stress the cables at the motor output.  
Do not tighten, twist or bend the power cable on the first 50 mm from motor side. Clamp the power cable after those 50 mm.
- ✓ When designing the assembly, take care to insure a perfect contact between housing and user's bore for avoiding thermal problems.
- ✓ For housing mounting, use either external centering diameter (B) or internal centering diameters (A).
- ✓ For execution tolerances (perpendicularity, concentricity...), please consult us.
- ✓ Fluid input and output pipes have to be placed at the opposite of wire outputs on the same axial plane.
- ✓ O-ring grooves designed for 3 mm diameter o-rings.

A full integration handbook can be supplied to our customers upon request  
For further information or specific request about our motors, feel free to contact us.

# TECHNICAL CHARACTERISTICS

## Windings for 400V / 460Vac drives (See Application note)

		300STK1M		300STK2M		300STK3M		300STK4M		300STK6M		300STK8M		
NATURAL CONVECTION	Rated speed	rpm	200	800	200	800	200	800	200	800	200	800	200	800
	Continuous torque at stall (1)(4)	N.m	54		98		145		184		261		319	
	Current at continuous torque (1)	A	4.2	10.7	7	17.6	9	27	11.2	36	15.5	48.5	20.3	65
	Peak torque (2)(3)	N.m	194		387		580		774		1161		1548	
	Current at peak torque (2)	A	20.9	50.7	36.7	92.6	50.6	152	66.5	212.9	96.8	304.1	133.1	425.8
	Rated power (1)	kW	1.06	3.65	2	7.06	2.89	8.9	3.65	10.92	4.7	13.86	5.8	15.12
	Inertia	10 <sup>-3</sup> kg.m <sup>2</sup>	26.4		52.7		79.2		105.5		158.2		211	
	Weight	kg	11.5		18		24.5		31		44		57	
	Thermal time constant (1)	s	495		669		907		1145		1621		2097	
	Thermal resistance (1)	°C / W	0.184		0.164		0.15		0.135		0.115		0.1	
	Phase resistance at 20°C (2)	Ω	7.05	1.09	2.82	0.44	1.85	0.205	1.286	0.126	0.808	0.082	0.54	0.053
	Phase inductance at I continuous	mH	27.4	4.1	17.7	2.8	13.9	1.53	11.1	1.1	7.8	0.8	5.5	0.53
	Electrical time constant (2)	ms	3.88		6.3		7.5		8.6		9.7		10.2	
	Back emf constant (line to line) (2)	V/rad.s	8.02	3.15	9.13	3.62	9.93	3.31	10.07	3.15	10.38	3.31	10.04	3.14
	Power cable square section (7)	nxmm <sup>2</sup>	4x1.5		4x1.5	4x2.5	4x1.5	4x4	4x1.5	4x6	4x1.5	4x6	4x2.5	4x10
	Power cable diameter (7)	mm	Ø8.6		Ø8.6	Ø10.8	Ø8.6	Ø12.2	Ø8.6	Ø14	Ø8.6	4x Ø7.7	Ø10.8	4x Ø9.5
	Number of poles	24												

		300STK1M		300STK2M		300STK3M		300STK4M		300STK6M		300STK8M		
COMPLEMENTARY DATA FOR FLUID-COOLED MOTORS WINDING AT 60°C	Continuous torque at stall (4)	N.m	83		170		246		323		484		677	
	Current at continuous torque	A	6.5	16.5	12.2	30.8	16.2	48.7	21	67.4	34.2	116.5	44	140.8
	Fluid input temperature (5)(6)	°C	20		20		20		20		20		20	
	Fluid temperature rise	°C	5		8		8		7		7		10	
	Housing temperature	°C	< 25		< 30		< 30		< 30		< 30		< 30	
	Fluid flow	l / mn	4		4		4		5		7		7	
	Losses	W	1060		1540		1815		2075		2770		3760	
	Pressure drop	Bar	0.2		0.6		0.8		0.3		0.5		0.7	
	Power cable square section (7)	nxmm <sup>2</sup>	4x1.5		4x1.5	4x6	4x1.5	4x6	4x2.5	4x10	4x6	4x25	4x6	4x35
	Power cable diameter (7)	mm	Ø8.6		Ø8.6	Ø14	Ø8.6	4x Ø7.7	Ø10.8	4x Ø9.5	Ø14	4x Ø13	4x Ø7.7	4x Ø15

		300STK1M		300STK2M		300STK3M		300STK4M		300STK6M		300STK8M		
COMPLEMENTARY DATA FOR FLUID-COOLED MOTORS WINDING AT 140°C	Continuous torque at stall (4)	N.m	106		219		325		436		651		871	-
	Current at continuous torque	A	9	22.8	16.3	41	22.1	66.4	29.5	94.5	42.7	133.6	58.7	-
	Fluid input temperature (5)(6)	°C	20		20		20		20		20		20	-
	Fluid temperature rise	°C	5		8		10		7		7		10	-
	Housing temperature	°C	< 25		< 30		< 30		< 30		< 30		< 30	-
	Fluid flow	l / mn	8		7		7		12		16		14	-
	Losses	W	2440		3275		4020		4972		6384		7956	-
	Pressure drop	Bar	1.1		1.5		2		1.6		2.2		2.2	-
	Power cable square section (7)	nxmm <sup>2</sup>	4x1.5	4x4	4x1.5	4x6	4x4	4x10	4x4	4x25	4x6	4x35	4x10	-
	Power cable diameter (7)	mm	Ø8.6	Ø12.2	Ø8.6	4x Ø7.7	Ø12.2	4x Ø9.5	Ø12.2	4x Ø13	4x Ø7.7	4x Ø15	4x Ø9.5	-

- Thermal conditions:  
Ambient temperature 20°C  
Winding temperature rise 120°C  
Stator housing in contact with the ambient air or integral on all its peripheral area with a metallic armature in contact with the ambient air.  
Stator housing secured on a metallic frame having an area equal to twice the cross section of the housing.
- Cold motor at 20°C
- See torque vs speed characteristics on :  
<http://www.alxion.com/>
- Torque at stall or low speed.
- Fluid input temperature should not be lower for avoiding condensation inside the motor.
- For cooling fluid, use softened glycol-added water or fluids approved for closed cooling circuits.
- For currents lower than 38 Amps, one shielded cable  
For currents over 38 Amps, four single shielded wires output (highlighted in the table)

Other speed characteristics are available, please contact us.



# TORQUE VS SPEED CURVES MOTORS 300STK

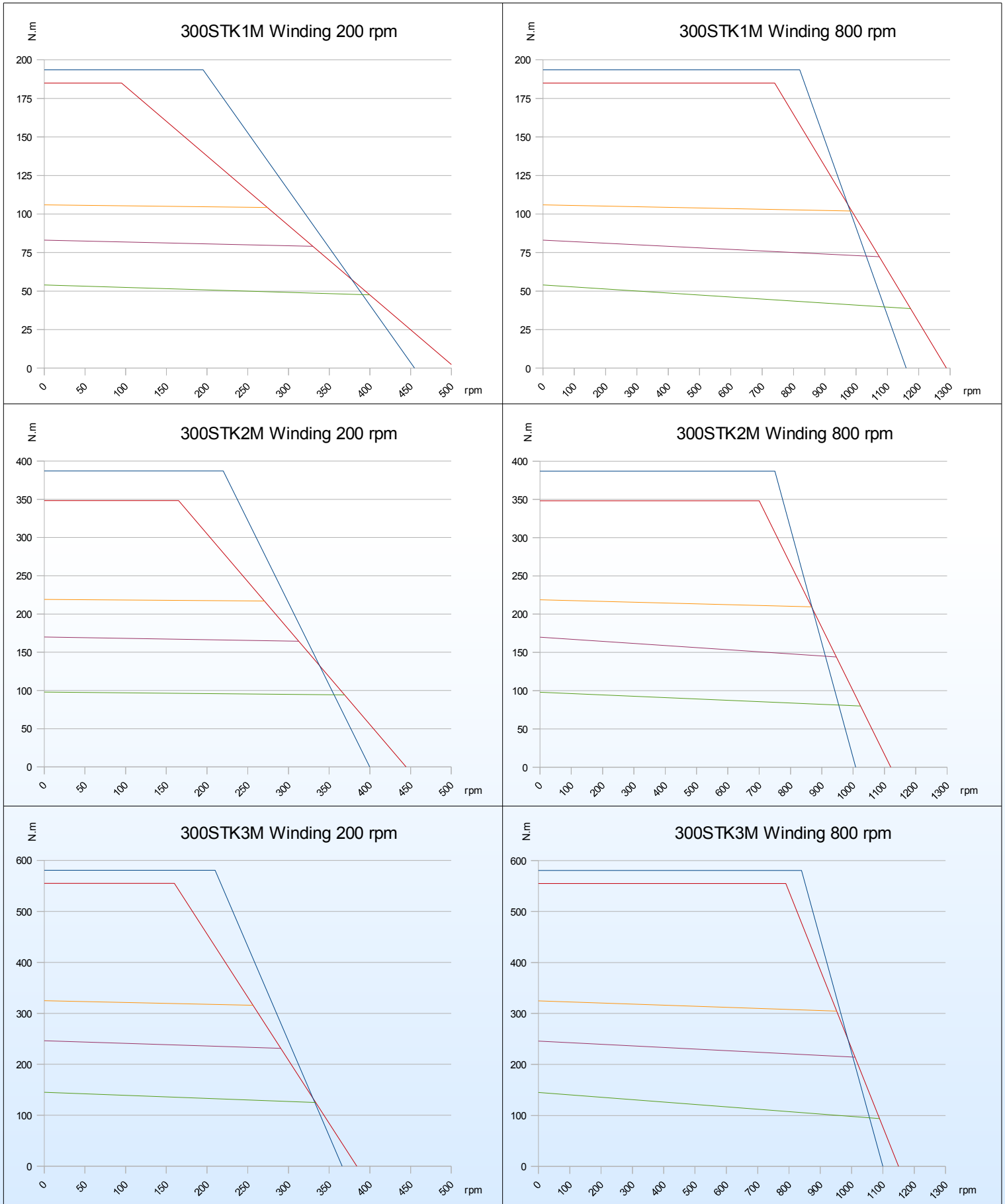

- Continuous torque with natural convection
- Continuous torque liquid cooled winding at 60°C
- Continuous torque liquid cooled winding at 140°C
- Max. transient characteristics motor at 20°C 400VAC mains / 540VDC bus with flux vector control
- Max. transient characteristics motor at rated temp 400VAC mains / 540VDC bus with flux vector control

Other windings can be supplied for matching your needs ; please contact us.

# TORQUE VS SPEED CURVES MOTORS 300STK

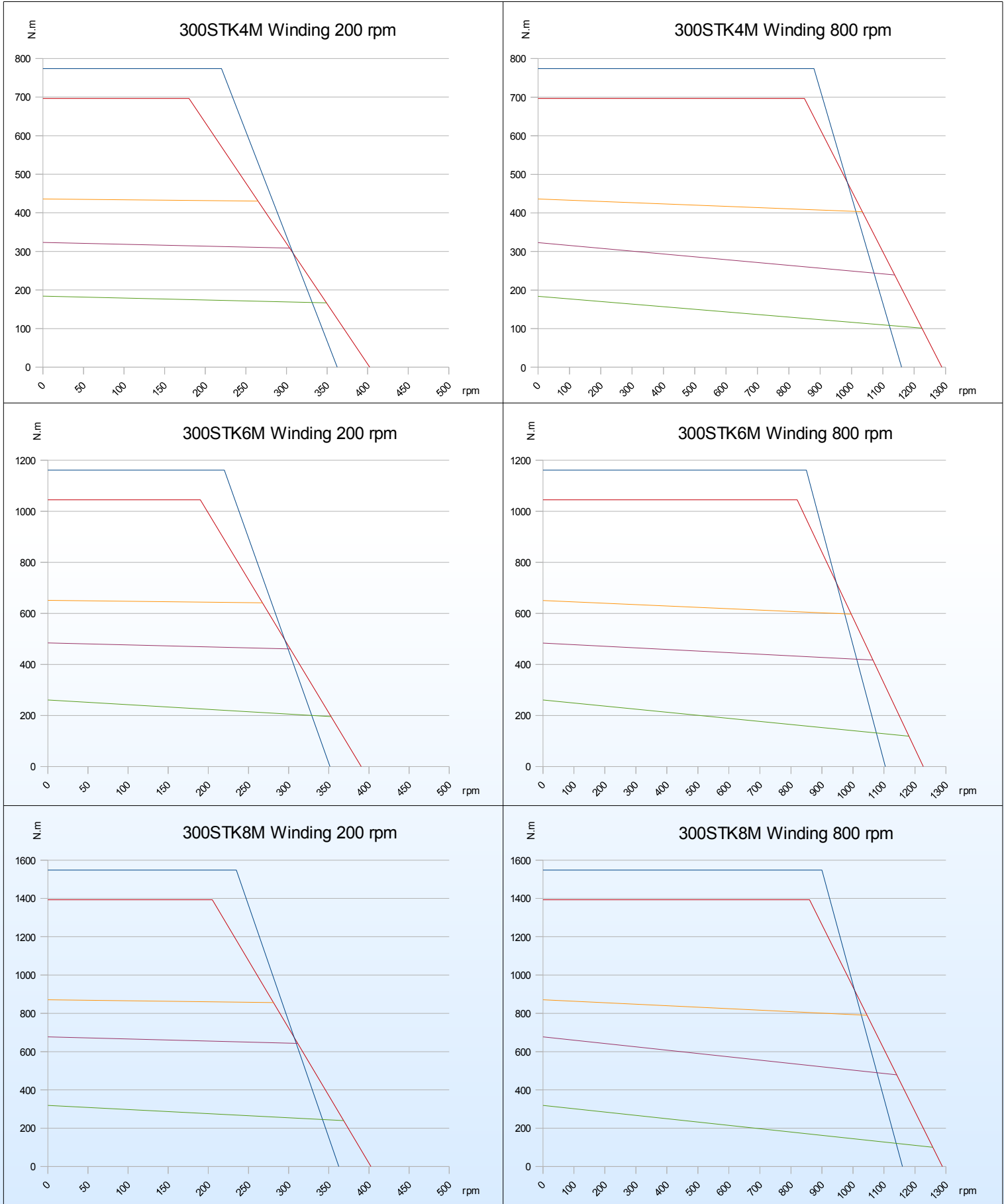

- Continuous torque with natural convection
- Continuous torque liquid cooled winding at 60°C
- Continuous torque liquid cooled winding at 140°C
- Max. transient characteristics motor at 20°C 400VAC mains / 540VDC bus with flux vector control
- Max. transient characteristics motor at rated temp 400VAC mains / 540VDC bus with flux vector control

Other windings can be supplied for matching your needs ; please contact us.

## Natural convection

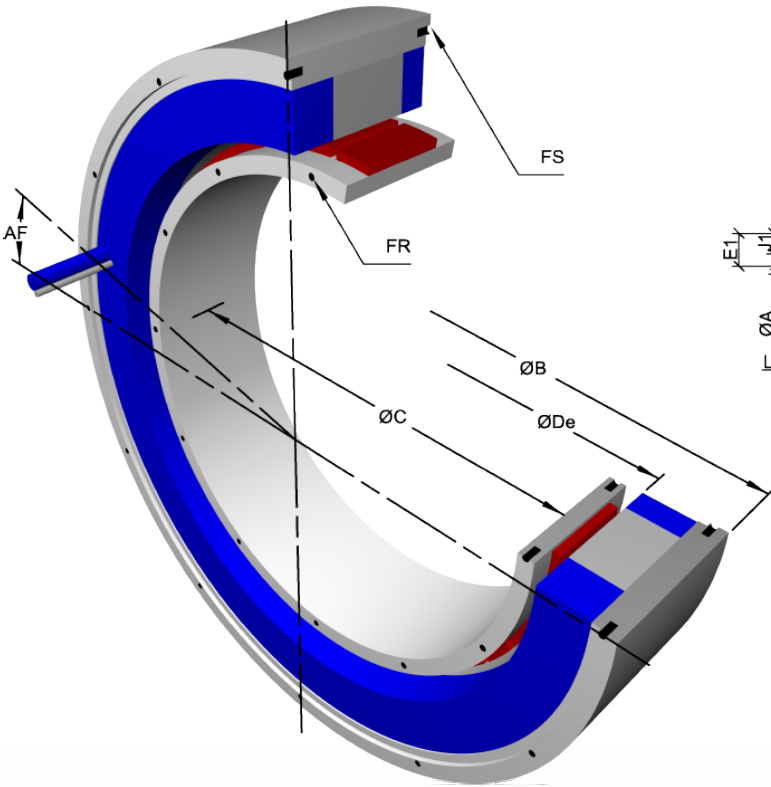

## Fluid cooling

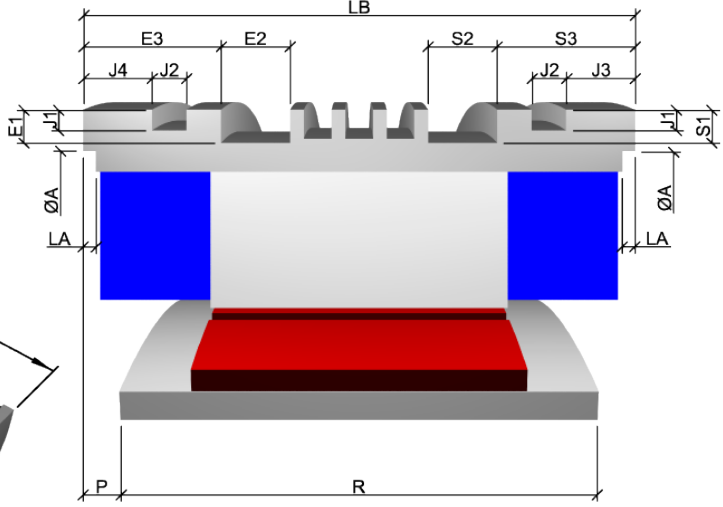

**DIMENSIONS FOR ALL 400 STK**

Housing internal centering diameter	A H8	380
Angle wire output / tapped holes	AF	15°
Housing external centering diameter (fluid cooling)	B f8	404
Housing external centering diameter (natural convection)	B f8	404
Rotoric internal centering diameter	C H7	258
Housing internal diameter	De	306
Depth of fluid front input / output groove	E1	5.5
Width of fluid front input / output groove	E2	9.3
Position of fluid front I/O groove	E3	27.2 (57.2)
Rotoric fixation holes	FR	12xM6 sur Ø268
Housing fixation holes	FS	12xM6 sur Ø390
O-ring groove depth	J1	3.4
O-ring groove width	J2	5.2
Position of rear o-ring groove	J3	18
Position of front o-ring groove	J4	18 (48)
Depth of housing internal centering diameter	LA	3
Alignment rotor / housing	P ± 0.1	39 (69)
Maximum rotoric contact diameter	Pmax	287
Depth of fluid rear I/O groove	S1	5.5
Width of fluid rear I/O groove	S2	9.3
Position of fluid rear I/O groove	S3	27.2

**DIMENSIONS ACCORDING TO SIZE**

		400S TK1M	400S TK2M	400S TK3M	400S TK4M	400S TK5M	400S TK6M	400S TK7M	400S TK8M
Housing length	LB ± 0.15	100.5 (130.5)	128 (158)	155.5 (185.5)	183 (213)	210.5 (240.5)	238 (268)	265.5 (295.5)	293 (323)
Rotor length	R + 0.15	27.5	55	82.5	110	137.5	165	192.5	220

The dimensions in red in the table are valid in the case of a rated current greater than 53 A and class 6 shielded cable output

We also offer the possibility of not shielded output wires without need of stator length increase.

### INTEGRATION:

- ✓ The cables are made of PU, class 6, foreseen for cable-bearing chains, 2 mt standard length, copper square section according rated current.
- ✓ Rotor / housing alignment (P) has to be executed within +/- 0.1 mm. Optionally, we can supply a mounting tool for achieving that alignment in case of assembly without possibility of accurate alignment.
- ✓ Thermal devices cable consists of 2 shielded pairs 2x2x0.25mm<sup>2</sup> section, 7 mm max external diameter.
- ✓ (De) represents:
  - 1- The maximum diameter passing inside the housing.
  - 2- The minimum diameter necessary for rotor assembly.
- ✓ (Pmax) diameter for pieces in contact with the rotor must never be exceeded.
- ✓ Tapped holes on each side of rotor and housing are angularly aligned.
- ✓ Cable positioning (AF) is theoretical. Leave a free room with a +/- 10 arc degrees tolerance around that position, on a 50 mm height from the housing side, for avoiding to stress the cables at the motor output.  
Do not tighten, twist or bend the power cable on the first 50 mm from motor side. Clamp the power cable after those 50 mm.
- ✓ When designing the assembly, take care to insure a perfect contact between housing and user's bore for avoiding thermal problems.
- ✓ For housing mounting, use either external centering diameter (B) or internal centering diameters (A).
- ✓ For execution tolerances (perpendicularity, concentricity...), please consult us.
- ✓ Fluid input and output pipes have to be placed at the opposite of wire outputs on the same axial plane.
- ✓ O-ring grooves designed for 4 mm diameter o-rings.

A full integration handbook can be supplied to our customers upon request  
For further information or specific request about our motors, feel free to contact us.

# TECHNICAL CHARACTERISTICS

## Windings for 400V / 460Vac drives (See Application note)

			400STK1M		400STK2M		400STK3M		400STK4M		400STK6M		400STK8M	
NATURAL CONVECTION	Rated speed	rpm	200	800	200	800	200	800	200	800	200	800	200	-
	Continuous torque at stall	(1)(4) N.m	113		225		319		400		570		730	-
	Current at continuous torque	(1) A	8.7	23.5	14.5	46.8	18	52.2	24.5	77	34.9	103	41	-
	Peak torque	(2)(3) N.m	440		880		1320		1760		2640		3520	-
	Current at peak torque	(2) A	46.9	126	78.1	252.3	102.5	298	149.1	468.6	218.7	656	273.3	-
	Rated power	(1) kW	2.25	7.6	4.3	15.5	5.96	18.3	7.6	21	9.5	24	11.3	-
	Inertia	10 <sup>-3</sup> kg.m <sup>2</sup>	82		163		244		325		488		650	-
	Weight	kg	23		35		46.5		58		81		104	-
	Thermal time constant	(1) s	990		1307		1530		1756		2218		2547	-
	Thermal resistance	(1) °C / W	0.117		0.098		0.094		0.078		0.071		0.063	-
	Phase resistance at 20°C	(2) Ω	2.23	0.31	0.981	0.094	0.69	0.081	0.39	0.04	0.236	0.026	0.187	-
	Phase inductance at I continuous	mH	11.8	1.62	8.7	0.83	7.3	0.86	4.8	0.49	3.4	0.37	2.9	-
	Electrical time constant	(2) ms	5.6		8.9		10.6		12.3		14.4		15.5	-
	Back emf constant (line to line)	(2) V/rad.s	7.96	2.96	9.54	2.95	10.9	3.7	10	3.18	10.2	3.41	10.9	-
	Power cable square section	(7) nxmm <sup>2</sup>	4x1.5	4x4	4x1.5	4x10	4x2.5	4x10	4x4	4x16	4x6	4x25	4x10	-
	Power cable diameter	(7) mm	Ø8.6	Ø12.2	Ø8.6	Ø17.6	Ø10.8	Ø17.6	Ø12.2	4xØ11	Ø14	4xØ13	Ø17.6	-
Number of poles		24												

			400STK1M		400STK2M		400STK3M		400STK4M		400STK6M		400STK8M	
COMPLEMENTARY DATA FOR FLUID-COOLED MOTORS WINDING AT 60°C	Continuous torque at stall	(4) N.m	174		396		561		780		1133		1428	-
	Current at continuous torque	A	13.6	36.5	27	87.2	33.4	97.3	51	160	72.2	216	85	-
	Fluid input temperature	(5)(6) °C	20		20		20		20		20		20	-
	Fluid temperature rise	°C	8		8		10		10		10		10	-
	Housing temperature	°C	< 30		< 30		< 30		< 30		< 30		< 30	-
	Fluid flow	l / mn	4		7		5		7		8		9	-
	Losses	W	1645		2760		3027		3660		4420		4940	-
	Pressure drop	Bar	0.1		0.9		0.75		0.4		0.4		0.6	-
	Power cable square section	(7) nxmm <sup>2</sup>	4x1.5	4x6	4x4	4x16	4x6	4x25	4x10	4x50	4x16	4x70	4x16	-
	Power cable diameter	(7) mm	Ø8.6	Ø14	Ø12.2	4xØ11	Ø14	4xØ13	Ø17.6	4xØ17	4xØ11	4xØ20	4xØ11	-

			400STK1M		400STK2M		400STK3M		400STK4M		400STK6M		400STK8M	
COMPLEMENTARY DATA FOR FLUID-COOLED MOTORS WINDING AT 140°C	Continuous torque at stall	(4) N.m	225		467		698		935		1384	-	1846	-
	Current at continuous torque	A	18.7	50.4	32.7	106	42.5	123.6	62.6	197	90	-	113	-
	Fluid input temperature	(5)(6) °C	20		20		20		20		20	-	20	-
	Fluid temperature rise	°C	8		8		10		10		10	-	10	-
	Housing temperature	°C	< 30		< 30		< 30		< 30		< 30	-	< 30	-
	Fluid flow	l / mn	8		11		10		12		15	-	18	-
	Losses	W	3740		4830		5833		6580		8180	-	10400	-
	Pressure drop	Bar	0.6		1.9		2.3		0.9		1.2	-	2.1	-
	Power cable square section	(7) nxmm <sup>2</sup>	4x2.5	4x10	4x6	4x25	4x10	4x25	4x10	4x50	4x16	-	4x25	-
	Power cable diameter	(7) mm	Ø10.8	Ø17.6	Ø14	4xØ13	Ø17.6	4xØ13	4xØ9.5	4xØ17	4xØ11	-	4xØ13	-

- (1) Thermal conditions:  
Ambient temperature 20°C  
Winding temperature rise 120°C  
Stator housing in contact with the ambient air or integral on all its peripheral area with a metallic armature in contact with the ambient air.  
Stator housing secured on a metallic frame having an area equal to twice the cross section of the housing.
- (2) Cold motor at 20°C
- (3) See torque vs speed characteristics on :  
<http://www.alxion.com/>
- (4) Torque at stall or low speed.
- (5) Fluid input temperature should not be lower for avoiding condensation inside the motor.
- (6) For cooling fluid, use softened glycol-added water or fluids approved for closed cooling circuits.
- (7) For currents lower than 53 Amps, one shielded cable  
For currents over 53 Amps, four single shielded wires output (highlighted in the table)

Other speed characteristics are available, please contact us.

# TORQUE VS SPEED CURVES MOTORS 400STK

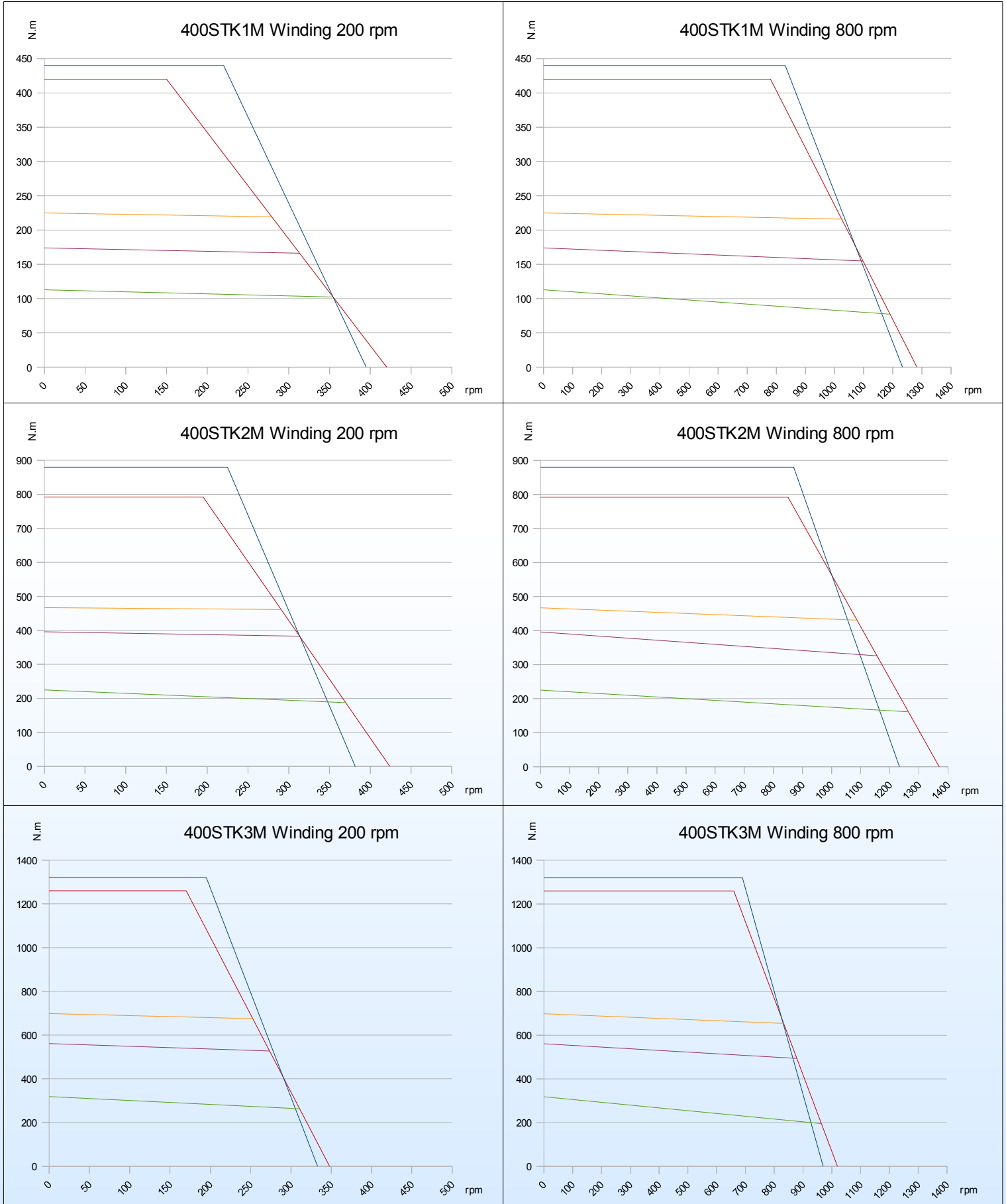

- Continuous torque with natural convection
- Continuous torque liquid cooled winding at 60°C
- Continuous torque liquid cooled winding at 140°C
- Max. transient characteristics motor at 20°C 400VAC mains / 540VDC bus with flux vector control
- Max. transient characteristics motor at rated temp 400VAC mains / 540VDC bus with flux vector control

Other windings can be supplied for matching your needs ; please contact us.

# TORQUE VS SPEED CURVES MOTORS 400STK

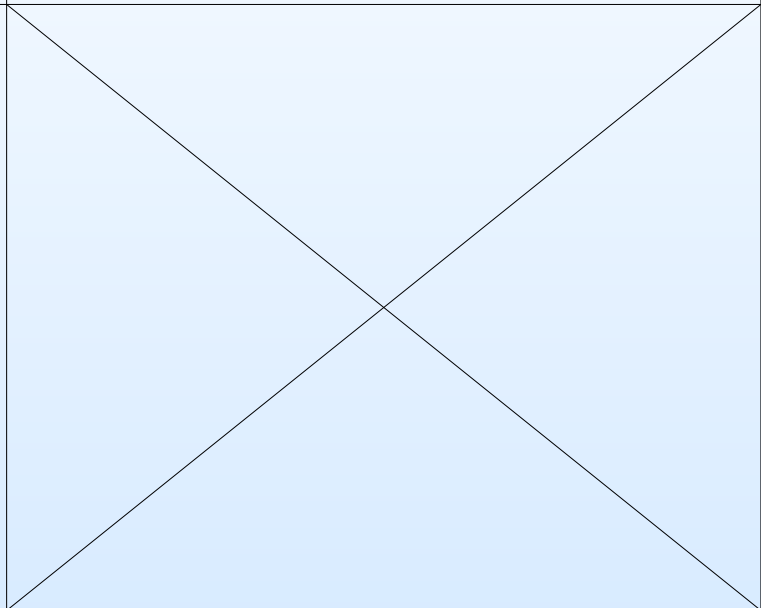
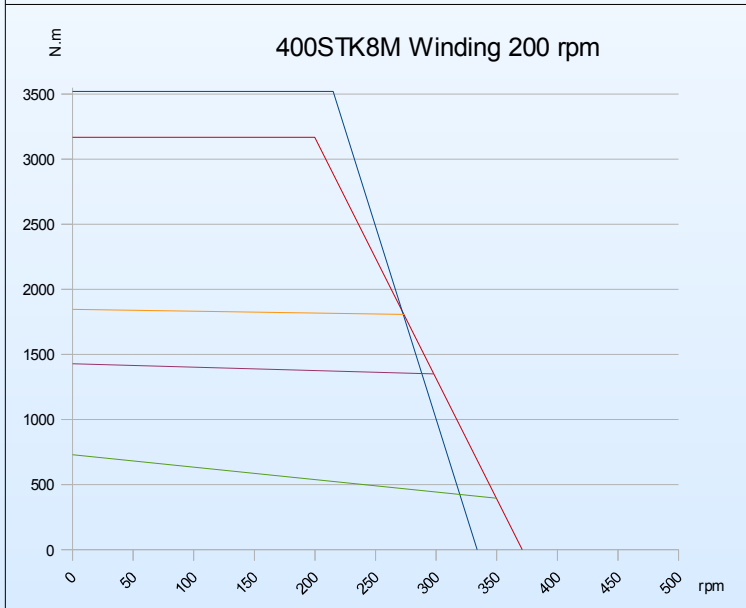
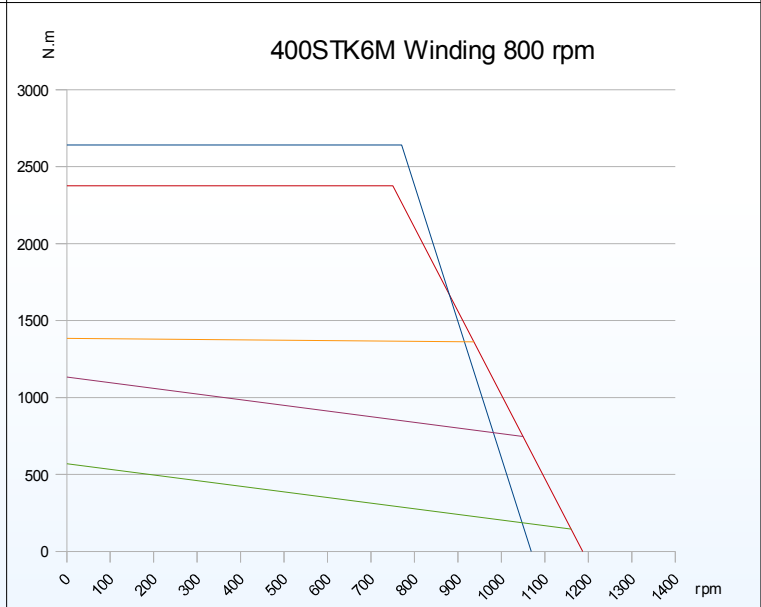
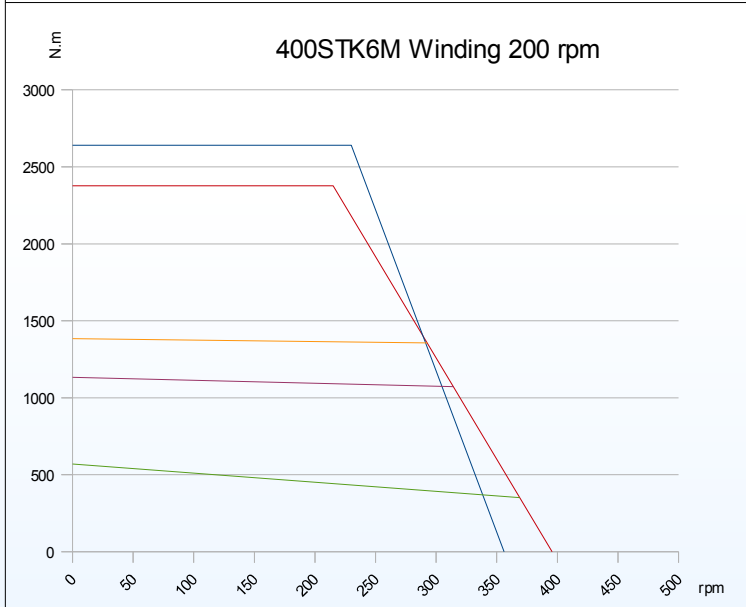
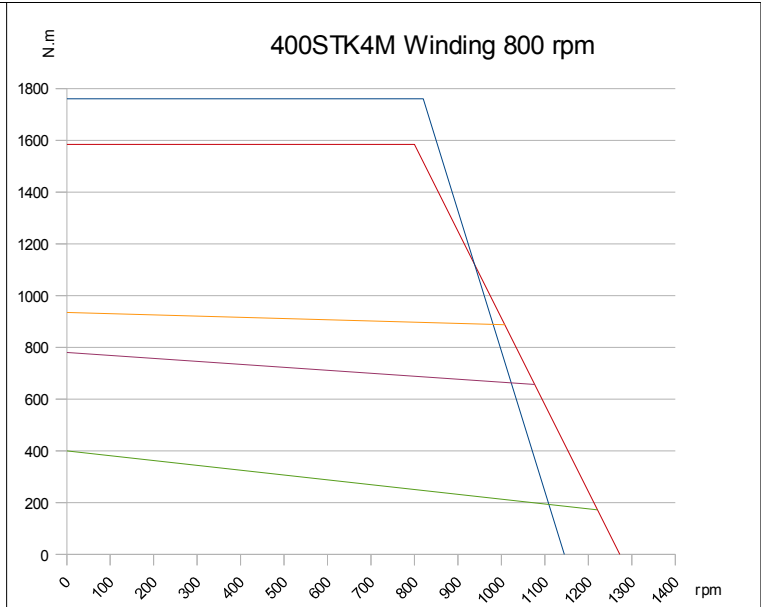
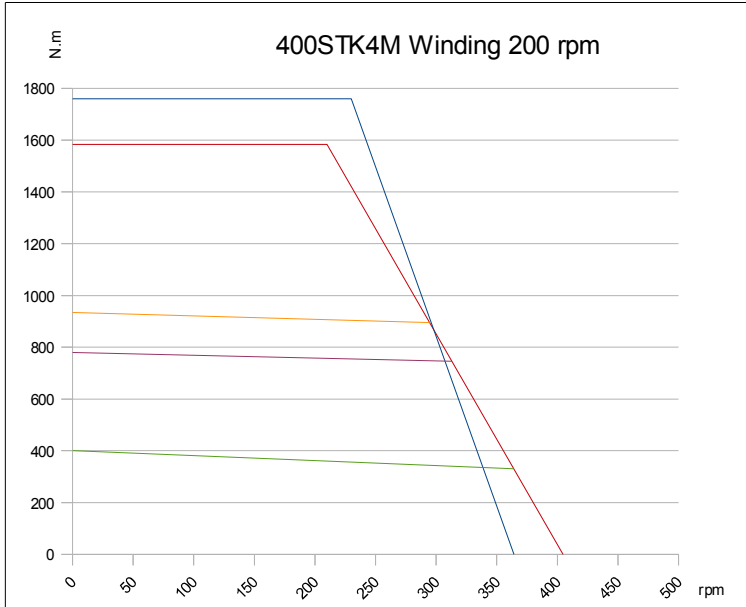

- Continuous torque with natural convection
- Continuous torque liquid cooled winding at 60°C
- Continuous torque liquid cooled winding at 140°C
- Max. transient characteristics motor at 20°C 400VAC mains / 540VDC bus with flux vector control
- Max. transient characteristics motor at rated temp 400VAC mains / 540VDC bus with flux vector control

Other windings can be supplied for matching your needs ; please contact us.

## Natural convection

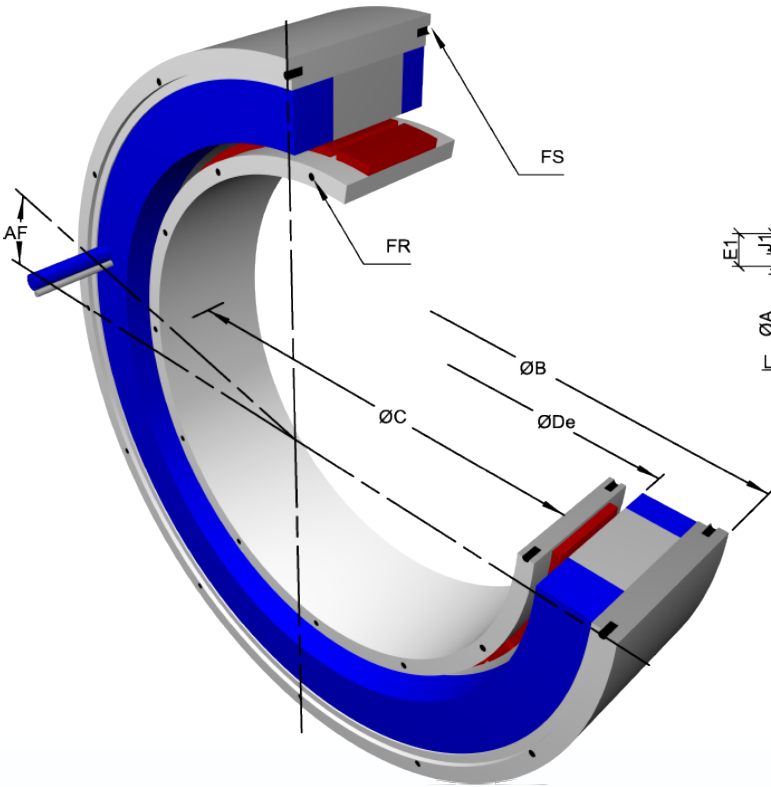

## Fluid cooling

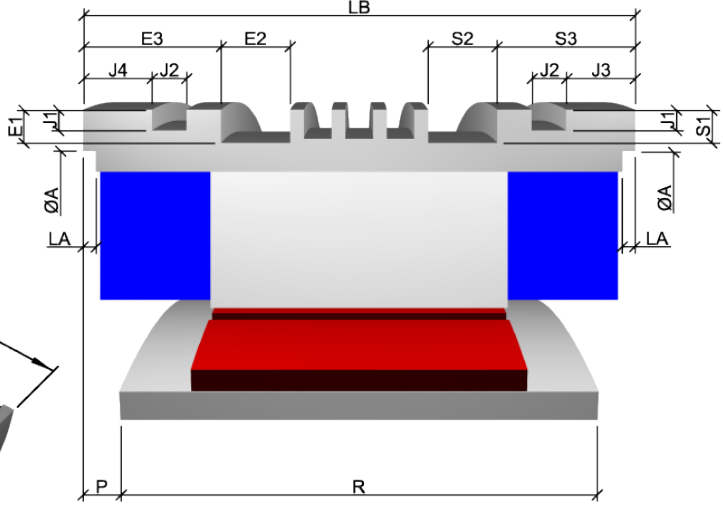

**DIMENSIONS FOR ALL 500 STK**

Housing internal centering diameter	A H8	470
Angle wire output / tapped holes	AF	15°
Housing external centering diameter (fluid cooling)	B f8	502
Housing external centering diameter (natural convection)	B f8	502
Rotoric internal centering diameter	C H7	350
Housing internal diameter	De	403
Depth of fluid front input / output groove	E1	5
Width of fluid front input / output groove	E2	18.95
Position of fluid front I/O groove	E3	23.2 (63.2)
Rotoric fixation holes	FR	12xM8 sur Ø364
Housing fixation holes	FS	12xM8 sur Ø482
O-ring groove depth	J1	3.4
O-ring groove width	J2	5.2
Position of rear o-ring groove	J3	9
Position of front o-ring groove	J4	14 (54)
Depth of housing internal centering diameter	LA	3
Alignment rotor / housing	P ± 0.1	37 (77)
Maximum rotoric contact diameter	Pmax	384
Depth of fluid rear I/O groove	S1	5
Width of fluid rear I/O groove	S2	18.9
Position of fluid rear I/O groove	S3	18.2

**DIMENSIONS ACCORDING TO SIZE**

		500STK1M	500STK2M	500STK3M	500STK4M	500STK5M	500STK6M	500STK7M	500STK8M	500STK9M
Housing length	LB ± 0.15	93 (133)	120.5 (160.5)	148 (188)	175.5 (215.5)	203 (243)	230.5 (270.5)	258 (298)	285.5 (325.5)	313 (353)
Rotor length	R + 0.15	27.5	55	82.5	110	137.5	165	192.5	220	247.5

The dimensions in red in the table are valid in the case of a rated current greater than 53 A and class 6 shielded cable output

We also offer the possibility of not shielded output wires without need of stator length increase.

**INTEGRATION:**

- ✓ The cables are made of PU, class 6, foreseen for cable-bearing chains, 2 mt standard length, copper square section according rated current.
- ✓ Rotor / housing alignment (P) has to be executed within +/- 0.1 mm. Optionally, we can supply a mounting tool for achieving that alignment in case of assembly without possibility of accurate alignment.
- ✓ Thermal devices cable consists of 2 shielded pairs 2x2x0.25mm<sup>2</sup> section, 7 mm max external diameter.
- ✓ (De) represents:
  - 1- The maximum diameter passing inside the housing.
  - 2- The minimum diameter necessary for rotor assembly.
- ✓ (Pmax) diameter for pieces in contact with the rotor must never be exceeded.
- ✓ Tapped holes on each side of rotor and housing are angularly aligned.
- ✓ Cable positioning (AF) is theoretical. Leave a free room with a +/- 10 arc degrees tolerance around that position, on a 50 mm height from the housing side, for avoiding to stress the cables at the motor output.
- Do not tighten, twist or bend the power cable on the first 50 mm from motor side. Clamp the power cable after those 50 mm.
- ✓ When designing the assembly, take care to insure a perfect contact between housing and user's bore for avoiding thermal problems.
- ✓ For housing mounting, use either external centering diameter (B) or internal centering diameters (A).
- ✓ For execution tolerances (perpendicularity, concentricity...), please consult us.
- ✓ Fluid input and output pipes have to be placed at the opposite of wire outputs on the same axial plane.
- ✓ O-ring grooves designed for 4 mm diameter o-rings.

A full integration handbook can be supplied to our customers upon request  
 For further information or specific request about our motors, feel free to contact us.

# TECHNICAL CHARACTERISTICS

## Windings for 400V / 460Vac drives (See Application note)

			500STK1M		500STK2M		500STK3M		500STK4M		500STK6M		500STK9M	
NATURAL CONVECTION	Rated speed	rpm	50	600	50	600	50	600	50	600	50	-	50	-
	Continuous torque at stall	(1)(4) N.m	210		365		520		640		878	-	1185	-
	Current at continuous torque	(1) A	7.3	37.4	9.2	58.3	13	82.3	14.8	91.8	18.8	-	23.1	-
	Peak torque	(2)(3) N.m	768		1536		2304		3072		4608	-	6912	-
	Current at peak torque	(2) A	32.4	166.3	46.7	295.6	70	443	85.8	532	120.9	-	166.3	-
	Rated power	(1) kW	1.05	9.95	1.8	19	2.6	24.3	3.3	27.3	4.6	-	6.22	-
	Inertia	10 <sup>-3</sup> kg.m <sup>2</sup>	216		433		649		865		1296	-	1944	-
	Weight	kg	27.4		43		58		73		103	-	148	-
	Thermal time constant	(1) s	1036		1593		2153		2710		3830	-	4670	-
	Thermal resistance	(1) °C / W	0.084		0.078		0.072		0.068		0.059	-	0.05	-
	Phase resistance at 20°C	(2) Ω	5.66	0.218	3.46	0.086	1.83	0.046	1.44	0.038	0.927	-	0.665	-
	Phase inductance at I continuous	mH	26.2	1	25.3	0.63	17	0.42	15.1	0.4	11.5	-	9.2	-
	Electrical time constant	(2) ms	4.6		7.3		9.3		10.5		12.4	-	13.8	-
	Back emf constant (line to line)	(2) V/rad.s	18.91	3.69	26.23	4.15	26.28	4.15	28.59	4.61	30.43	-	33.2	-
	Power cable square section	(7) nxmm <sup>2</sup>	4x1.5	4x6	4x1.5	4x10	4x1.5	4x16	4x1.5	4x16	4x2.5	-	4x4	-
	Power cable diameter	(7) mm	Ø8.6	Ø14	Ø8.6	4x Ø9.5	Ø8.6	4x Ø11	Ø8.6	4x Ø11	Ø10.8	-	Ø12.2	-
	Number of poles		36											

			500STK1M		500STK2M		500STK3M		500STK4M		500STK6M		500STK9M	
COMPLEMENTARY DATA FOR FLUID-COOLED MOTORS WINDING AT 60°C	Continuous torque at stall	(4) N.m	285		588		831		1122		1731	-	2530	-
	Current at continuous torque	A	9.9	50.7	14.8	93.7	20.7	131	25.9	160.6	37.3	-	50	-
	Fluid input temperature	(5)(6) °C	20		20		20		20		20	-	20	-
	Fluid temperature rise	°C	6		6		6		5		6	-	8	-
	Housing temperature	°C	< 30		< 30		< 30		< 30		< 30	-	< 30	-
	Fluid flow	l / mn	5		8		9		12		14	-	14	-
	Losses	W	2090		2790		2970		3570		4870	-	6190	-
	Pressure drop	Bar	0.1		0.4		0.3		0.4		0.4	-	0.6	-
	Power cable square section	(7) nxmm <sup>2</sup>	4x1.5	4x10	4x1.5	4x16	4x2.5	4x35	4x4	4x50	4x6	-	4x10	-
	Power cable diameter	(7) mm	Ø8.6	Ø17.6	Ø8.6	4x Ø11	Ø10.8	4x Ø15	Ø12.2	4x Ø17	Ø14	-	Ø17.6	-

			500STK1M		500STK2M		500STK3M		500STK4M		500STK6M		500STK9M	
COMPLEMENTARY DATA FOR FLUID-COOLED MOTORS WINDING AT 140°C	Continuous torque at stall	(4) N.m	380		785		1180		1550		2394	-	3590	-
	Current at continuous torque	A	13.5	69.2	20.3	130	30.7	194	37.2	230.5	54	-	73.4	-
	Fluid input temperature	(5)(6) °C	20		20		20		20		20	-	20	-
	Fluid temperature rise	°C	6		6		6		6		6	-	8	-
	Housing temperature	°C	25		25		25		< 25		25	-	< 30	-
	Fluid flow	l / mn	14		18		23		25		35	-	35	-
	Losses	W	4620		6260		7760		8770		12160	-	15890	-
	Pressure drop	Bar	0.4		1.8		1.3		1.6		2	-	3	-
	Power cable square section	(7) nxmm <sup>2</sup>	4x1.5	4x10	4x2.5	4x35	4x6	4x50	4x6	4x70	4x10	-	4x16	-
	Power cable diameter	(7) mm	Ø8.6	4x Ø9.5	Ø10.8	4x Ø15	Ø14	4x Ø17	Ø14	4x Ø20	4x Ø9.5	-	4x Ø11	-

- (1) Thermal conditions:  
Ambient temperature 20°C  
Winding temperature rise 120°C  
Stator housing in contact with the ambient air or integral on all its peripheral area with a metallic armature in contact with the ambient air.  
Stator housing secured on a metallic frame having an area equal to twice the cross section of the housing.
- (2) Cold motor at 20°C.
- (3) See torque vs speed characteristics on :  
<http://www.alxion.com/>
- (4) Torque at stall or low speed.
- (5) Fluid input temperature should not be lower for avoiding condensation inside the motor.
- (6) For cooling fluid, use softened glycol-added water or fluids approved for closed cooling circuits.
- (7) For currents lower than 53 Amps, one shielded cable  
For currents over 53 Amps, four single shielded wires output (highlighted in the table)

Other speed characteristics are available, please contact us.



# TORQUE VS SPEED CURVES MOTORS 500STK

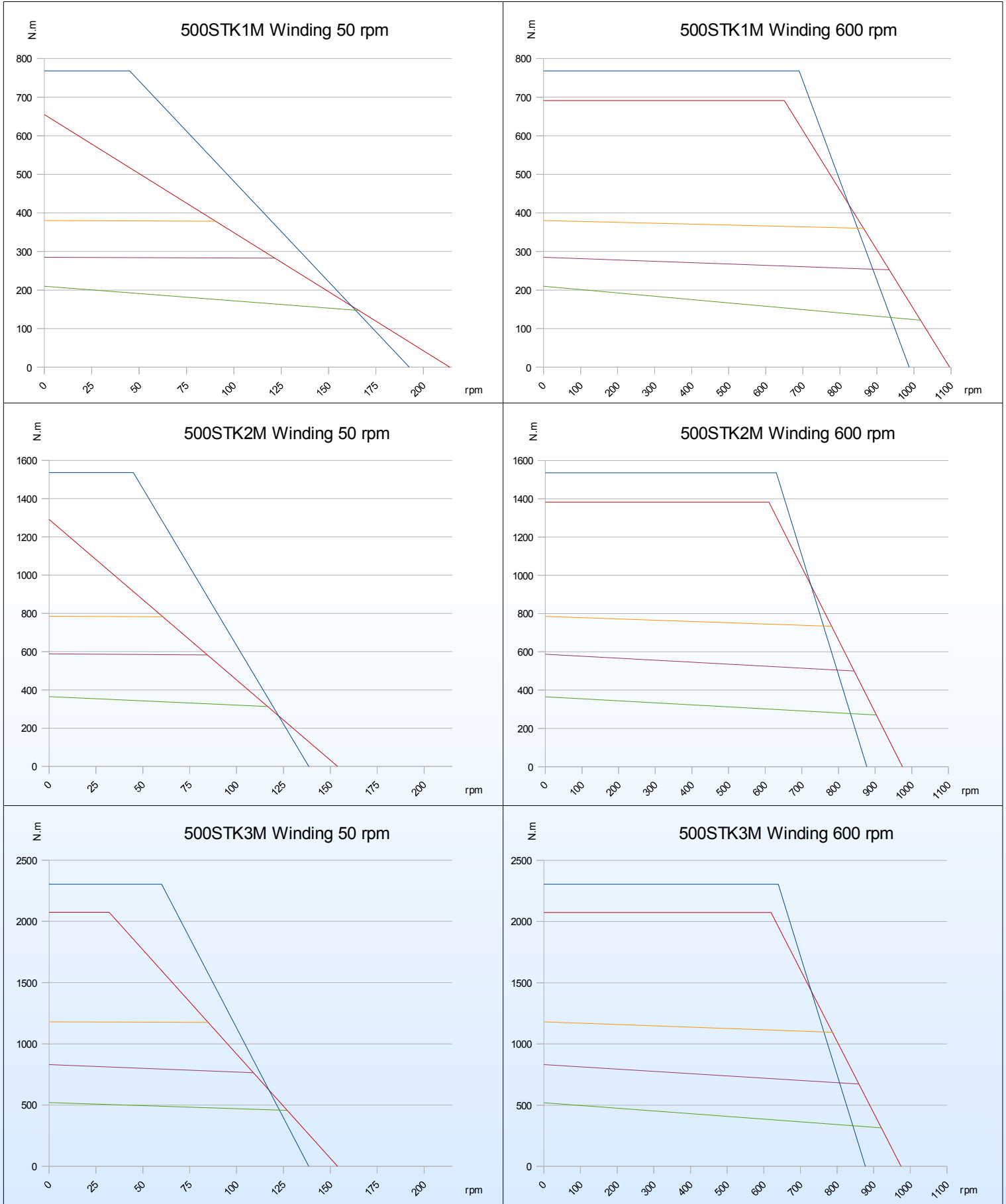

- Continuous torque with natural convection
- Continuous torque liquid cooled winding at 60°C
- Continuous torque liquid cooled winding at 140°C
- Max. transient characteristics motor at 20°C 400VAC mains / 540VDC bus with flux vector control
- Max. transient characteristics motor at rated temp 400VAC mains / 540VDC bus with flux vector control

Other windings can be supplied for matching your needs ; please contact us.

# TORQUE VS SPEED CURVES MOTORS 500STK

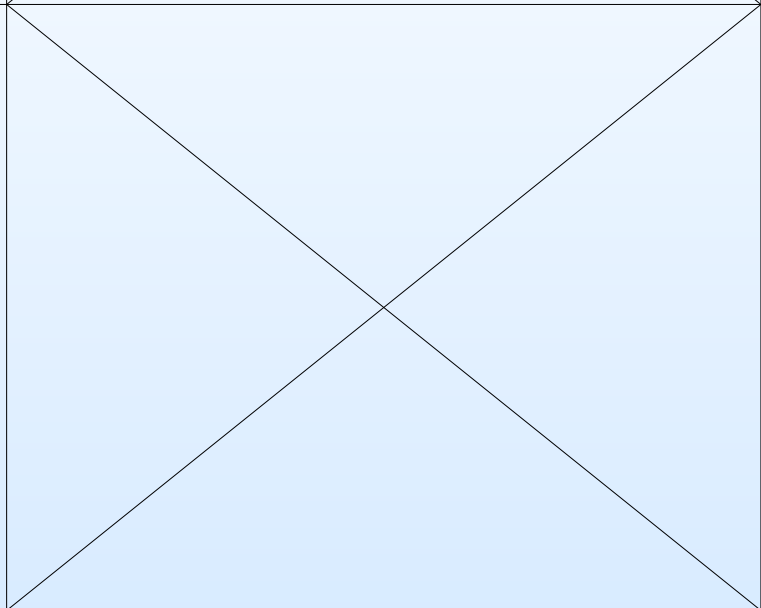
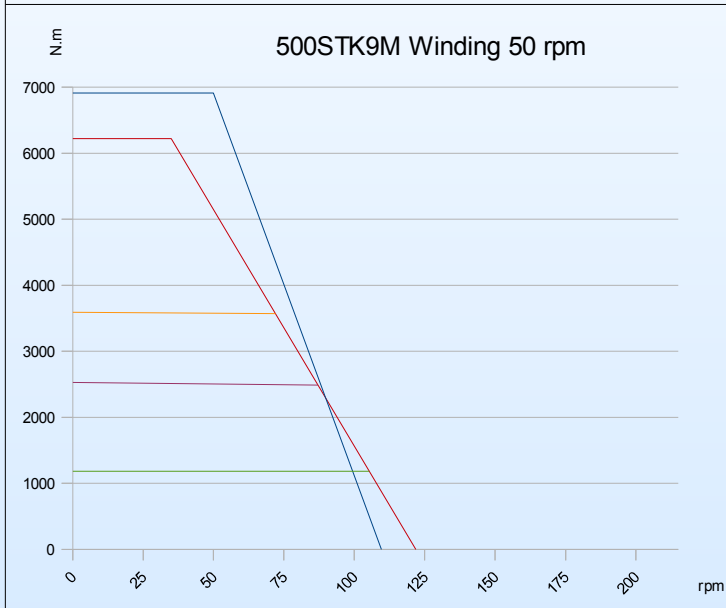
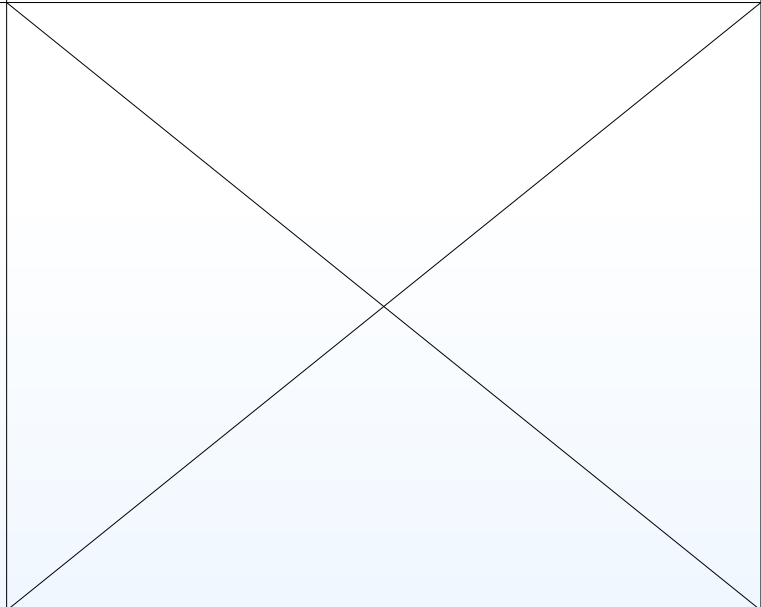
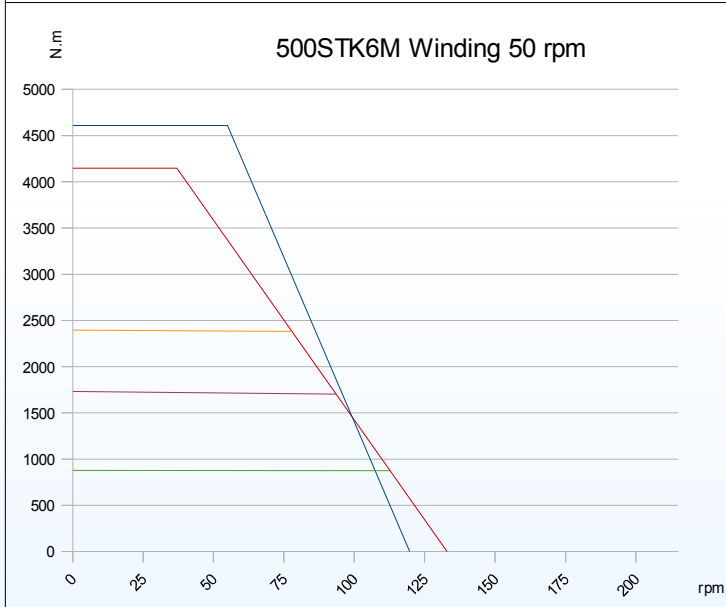
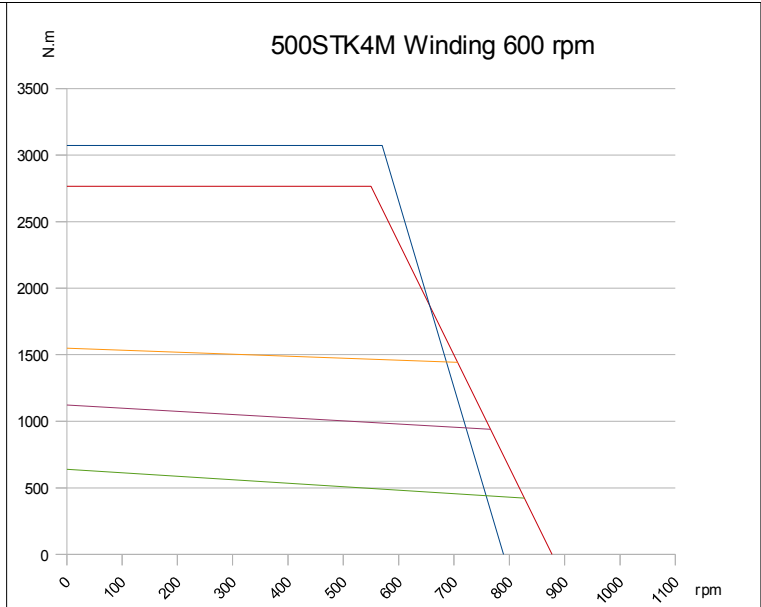
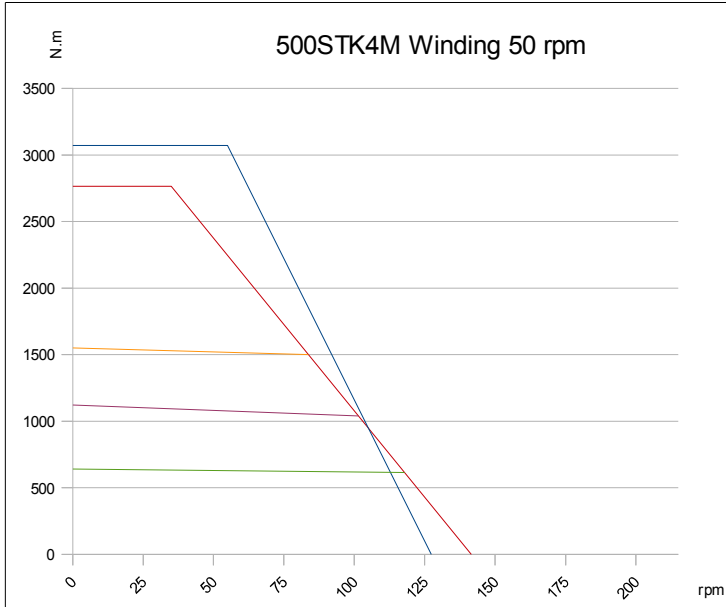

- Continuous torque with natural convection
- Continuous torque liquid cooled winding at 60°C
- Continuous torque liquid cooled winding at 140°C
- Max. transient characteristics motor at 20°C 400VAC mains / 540VDC bus with flux vector control
- Max. transient characteristics motor at rated temp 400VAC mains / 540VDC bus with flux vector control

Other windings can be supplied for matching your needs ; please contact us.

## Natural convection

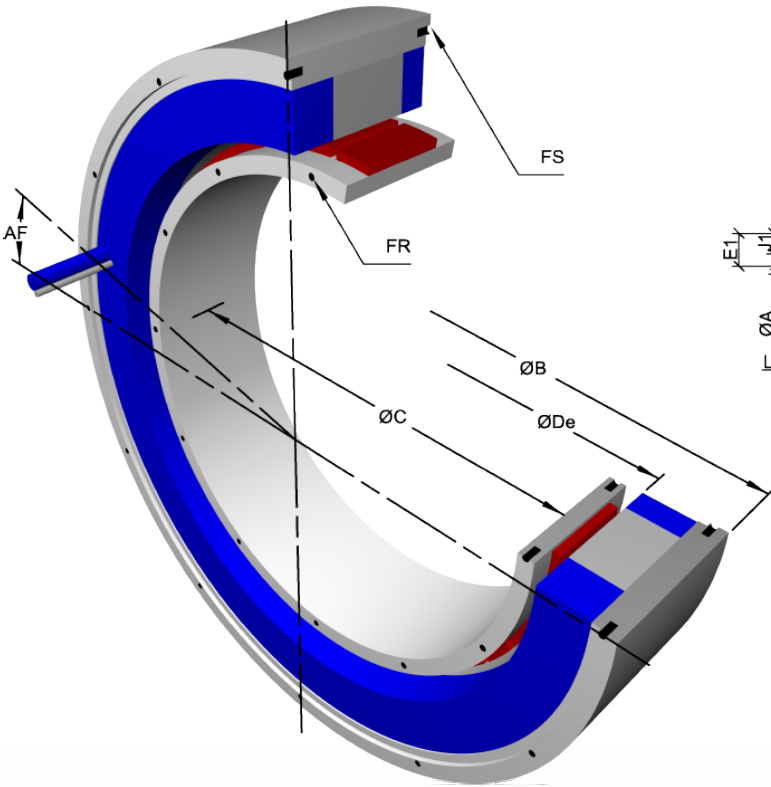

## Fluid cooling

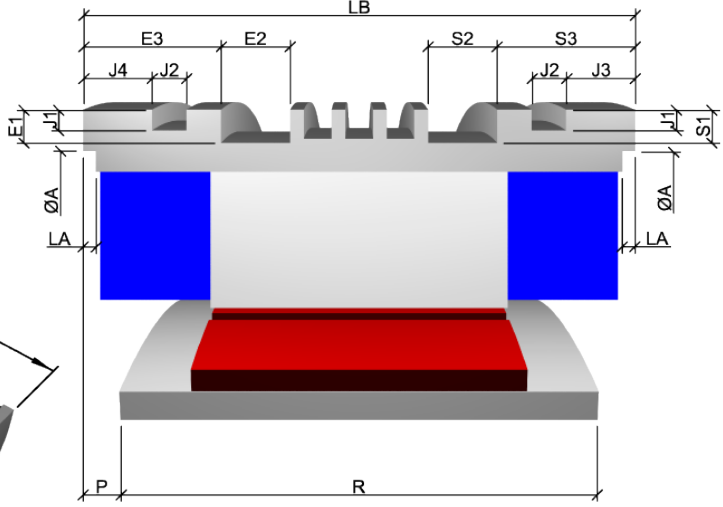

### DIMENSIONS FOR ALL 800 STK

Housing internal centering diameter	A H8	762
Angle wire output / tapped holes	AF	11.25°
Housing external centering diameter (fluid cooling)	B f8	795
Housing external centering diameter (natural convection)	B f8	795
Rotoric internal centering diameter	C H7	630
Housing internal diameter	De	689
Depth of fluid front input / output groove	E1	8
Width of fluid front input / output groove	E2	15.5
Position of fluid front I/O groove	E3	28 (68)
Rotoric fixation holes	FR	16xM8 sur Ø645
Housing fixation holes	FS	16xM8 sur Ø774
O-ring groove depth	J1	4.9
O-ring groove width	J2	7.4
Position of rear o-ring groove	J3	13.7
Position of front o-ring groove	J4	15.7 (55.7)
Depth of housing internal centering diameter	LA	5
Alignment rotor / housing	P ± 0.2	47 (87)
Maximum rotoric contact diameter	Pmax	666
Depth of fluid rear I/O groove	S1	8
Width of fluid rear I/O groove	S2	15.5
Position of fluid rear I/O groove	S3	26

### DIMENSIONS ACCORDING TO SIZE

		800STK1M	800STK2M	800STK4M	800STK6M
Housing length	LB±0.15	112.5 (152.5)	140 (180)	195 (235)	250 (290)
Rotor length	R +0.15	27.5	55	110	165

The dimensions in red in the table are valid in the case of a rated current greater than 53 A and class 6 shielded cable output

We also offer the possibility of not shielded output wires without need of stator length increase.

### INTEGRATION:

- ✓ The cables are made of PU, class 6, foreseen for cable-bearing chains, 2 mt standard length, copper square section according rated current.
- ✓ Rotor / housing alignment (P) has to be executed within +/- 0.2 mm. Optionally, we can supply a mounting tool for achieving that alignment in case of assembly without possibility of accurate alignment.
- ✓ Thermal devices cable consists of 2 shielded pairs 2x2x0.25mm<sup>2</sup> section, 7 mm max external diameter.
- ✓ (De) represents:
  - 1- The maximum diameter passing inside the housing.
  - 2- The minimum diameter necessary for rotor assembly.
- ✓ (Pmax) diameter for pieces in contact with the rotor must never be exceeded.
- ✓ Tapped holes on each side of rotor and housing are angularly aligned.
- ✓ Cable positioning (AF) is theoretical. Leave a free room with a +/- 5 arc degrees tolerance around that position, on a 50 mm height from the housing side, for avoiding to stress the cables at the motor output.  
Do not tighten, twist or bend the power cable on the first 50 mm from motor side. Clamp the power cable after those 50 mm.
- ✓ When designing the assembly, take care to insure a perfect contact between housing and user's bore for avoiding thermal problems.
- ✓ For housing mounting, use either external centering diameter (B) or internal centering diameters (A).
- ✓ For execution tolerances (perpendicularity, concentricity...), please consult us.
- ✓ Fluid input and output pipes have to be placed at the opposite of wire outputs on the same axial plane.
- ✓ O-ring grooves designed for 6 mm diameter o-rings.

A full integration handbook can be supplied to our customers upon request  
For further information or specific request about our motors, feel free to contact us.

# TECHNICAL CHARACTERISTICS

## Windings for 400V / 460Vac drives (See Application note)

			800STK1M		800STK2M		800STK4M		800STK6M	
NATURAL CONVECTION	Rated speed	rpm	30	250	30	250	30	250	30	-
	Continuous torque at stall (1)(4)	N.m	610		1127		2010		2708	
	Current at continuous torque (1)	A	13.9	43.2	19	65.6	26.5	106	33.5	-
	Peak torque (2)(3)	N.m	1885		3770		7540		11310	
	Current at peak torque (2)	A	50.8	158	74.9	258.6	118.5	474.2	167.4	-
	Rated power (1)	kW	1.92	15.01	3.5	22.6	6.3	33.1	8.53	-
	Inertia	10 <sup>-3</sup> kg.m <sup>2</sup>	1270		2540		5080		7620	
	Weight	kg	55		82		138		193	
	Thermal time constant (1)	s	444		685		1166		1656	
	Thermal resistance (1)	°C / W	0.035		0.033		0.03		0.028	
	Phase resistance at 20°C (2)	Ω	3.16	0.326	1.66	0.139	0.95	0.06	0.585	-
	Phase inductance at I continuous	mH	15.4	1.6	14.2	1.2	11.3	0.7	8.6	-
	Electrical time constant (2)	ms	4.9		8.5		11.9		14.7	
	Back emf constant (line to line) (2)	V/rad.s	28.6	9.2	38.9	11.2	48.94	12.3	52.1	-
	Power cable square section (7)	nxmm <sup>2</sup>	4x1.5	4x10	4x2.5	4x10	4x4	4x25	4x6	-
	Power cable diameter (7)	mm	Ø8.6	Ø17.6	Ø10.8	4xØ9.5	Ø12.2	4xØ13	Ø14	-
Number of poles		48								

			800STK1M		800STK2M		800STK4M		800STK6M	
COMPLEMENTARY DATA FOR FLUID-COOLED MOTORS WINDING AT 60°C	Continuous torque at stall (4)	N.m	803		1580		3160		4720	
	Current at continuous torque	A	18.2	53.6	26.3	90.9	41.5	166	58.5	-
	Fluid input temperature (5)(6)	°C	20		20		20		20	
	Fluid temperature rise	°C	10		10		10		10	
	Housing temperature	°C	32		30		< 30		< 30	
	Fluid flow	l / mn	7		8		11		15	
	Losses	W	3710		4110		5830		7400	
	Pressure drop	Bar	< 0.1		0.1		0.3		0.7	
	Power cable square section (7)	nxmm <sup>2</sup>	4x2.5	4x10	4x4	4x16	4x10	4x50	4x10	-
	Power cable diameter (7)	mm	Ø10.8	4xØ9.5	Ø12.2	4xØ11	Ø17.6	4xØ17	4xØ9.5	-

			800STK1M		800STK2M		800STK4M		800STK6M	
COMPLEMENTARY DATA FOR FLUID-COOLED MOTORS WINDING AT 140°C	Continuous torque at stall (4)	N.m	1039		2057		4100		6100	
	Current at continuous torque	A	24	74.7	35.2	121.6	55.5	222	77.4	-
	Fluid input temperature (5)(6)	°C	20		20		20		20	
	Fluid temperature rise	°C	10		10		10		10	
	Housing temperature	°C	31		< 30		< 30		< 30	
	Fluid flow	l / mn	14		16		23		29	
	Losses	W	7940		9060		12830		15850	
	Pressure drop	Bar	0.2		0.3		1.2		2.1	
	Power cable square section (7)	nxmm <sup>2</sup>	4x4	4x16	4x6	4x25	4x10	4x70	4x16	-
	Power cable diameter (7)	mm	Ø12.2	4xØ11	Ø14	4xØ13	4xØ9.5	4xØ20	4xØ11	-

(1) Thermal conditions:

Ambient temperature 20°C

Winding temperature rise 120°C

Stator housing in contact with the ambient air or integral on all its peripheral area with a metallic armature in contact with the ambient air.

Stator housing secured on a metallic frame having an area equal to twice the cross section of the housing.

(2) Cold motor at 20°C.

(3) See torque vs speed characteristics on :

<http://www.alxion.com/>

(4) Torque at stall or low speed.

(5) Fluid input temperature should not be lower for avoiding condensation inside the motor.

(6) For cooling fluid, use softened glycol-added water or fluids approved for closed cooling circuits.

(7) For currents lower than 53 Amps, one shielded cable

For currents over 53 Amps, four single shielded wires output (highlighted in the table)

Other speed characteristics are available, please contact us.

# TORQUE VS SPEED CURVES MOTORS 800STK

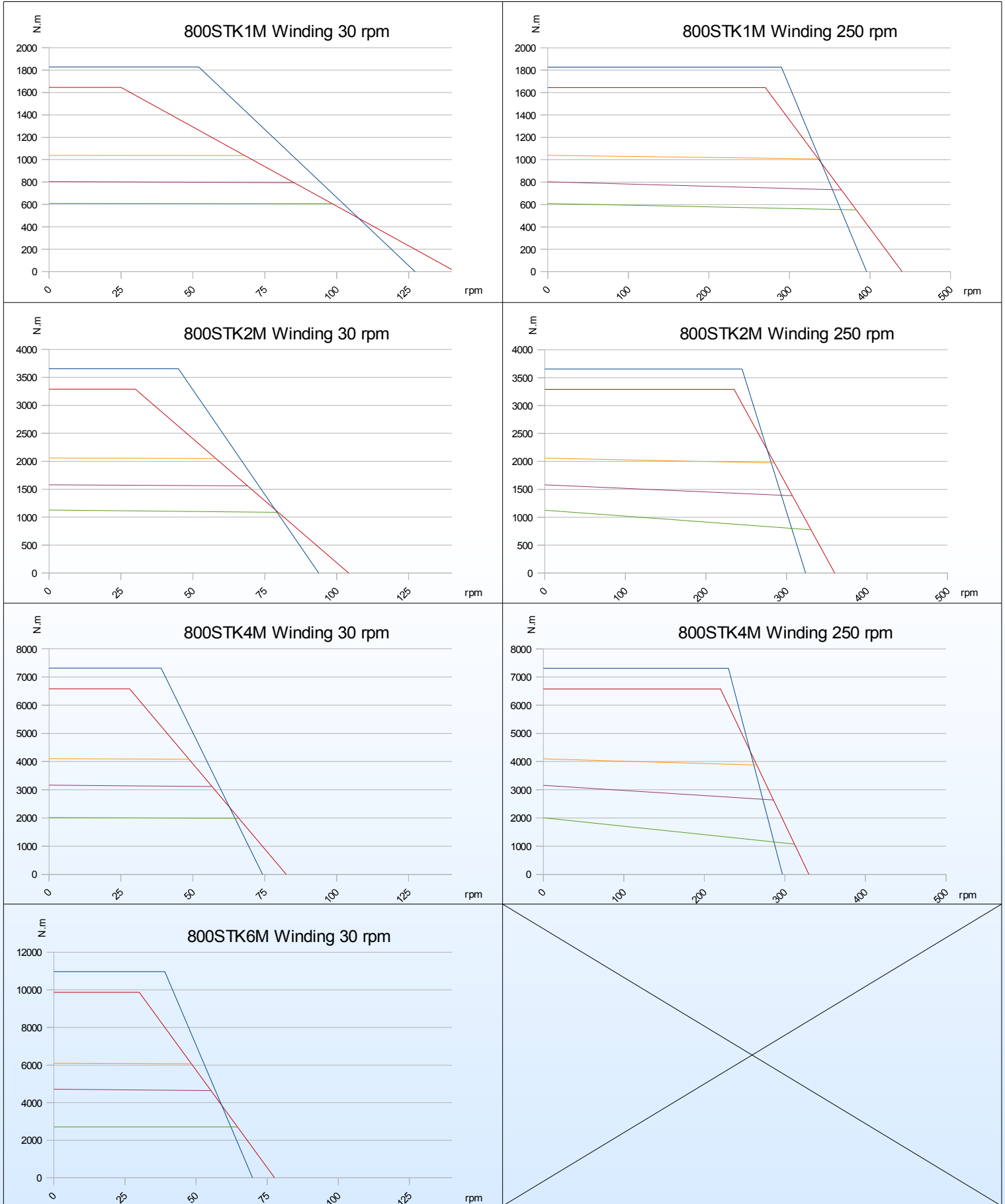

- Continuous torque with natural convection
- Continuous torque liquid cooled winding at 60°C
- Continuous torque liquid cooled winding at 140°C
- Max. transient characteristics motor at 20°C 400VAC mains / 540VDC bus with flux vector control
- Max. transient characteristics motor at rated temp 400VAC mains / 540VDC bus with flux vector control

Other windings can be supplied for matching your needs ; please contact us.



# CODIFICATION FOR STK MOTORS

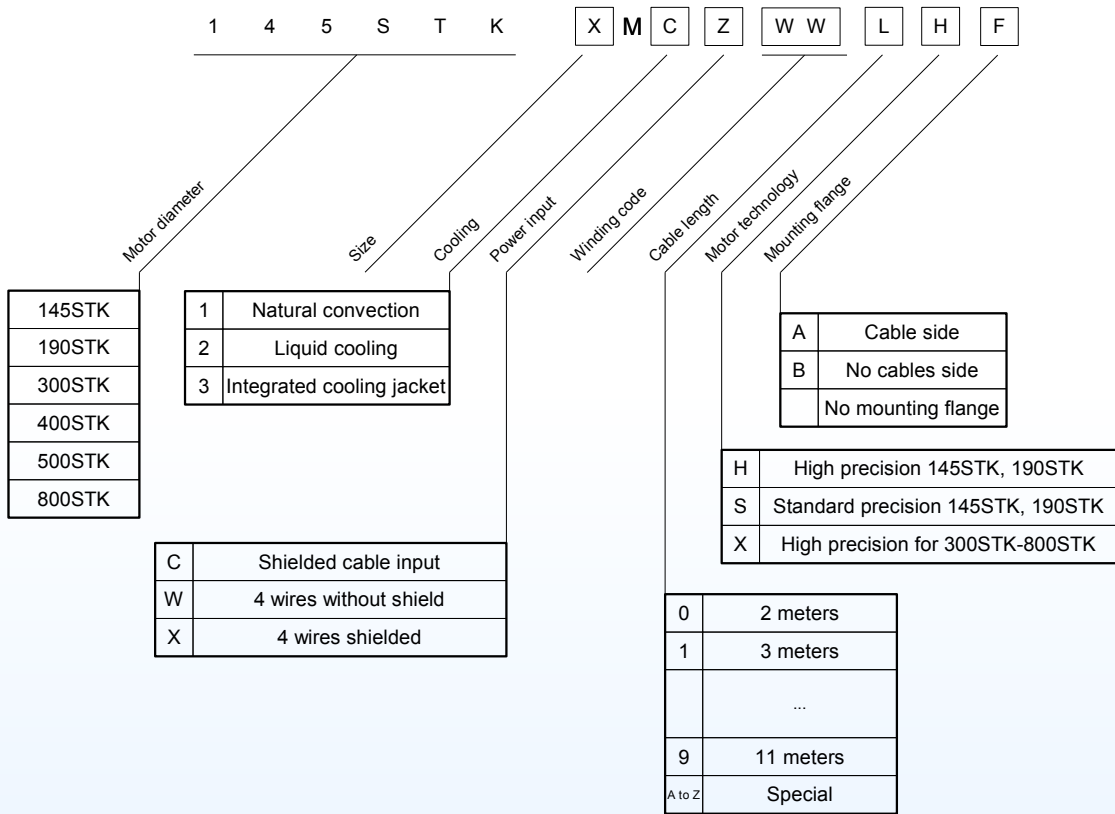

## C: Cooling:

- 1: Natural convection:  
Motor housing without cooling grooves
- 2: Liquid cooling:  
Motor housing with cooling grooves
- 3: Integrated cooling jacket:  
Motor with integrated cooling jacket (see table for dimensions)

## W: Winding code:

- 01: Low speed in table of characteristics
- 02: High speed in table of characteristics
- XX: Special windings, contact us

## H: Motor technology:

- H: High precision technology ; cogging <1% of rated torque in natural convection (145STK-190STK)
- S: Standard precision technology ; cogging ≤2% of rated torque in natural convection (145STK-190STK)
- X: High precision technology ; cogging <2% of rated torque in natural convection (300STK-800STK)

## L: Cable length:

- 0 to 9 : Length since side of the motor
- A to Z : Length and/or specific square section

Join **ALXION** on its **WEB** site: <http://www.alxion.com>

Our site allows you to keep up with our products evolution, to download technical information or catalogues on your computer, to send us messages by e-mail.  
Keep in touch with us: Surf on our bilingual site!



## ACCESS TO OUR HEAD OFFICE

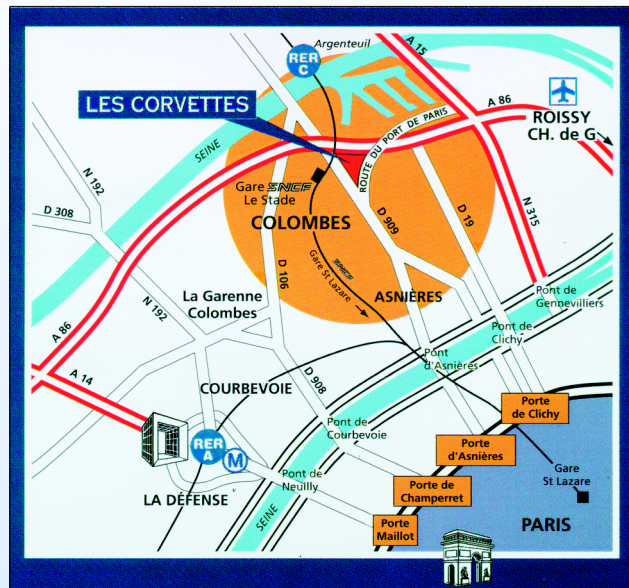

**ALXION**  
Automatique  
& Productique

Head Office: Parc Technologique "Les Fossés Jean"  
142-176, Avenue de Stalingrad  
F - 92712 COLOMBES Cedex  
Phone: (33) 1 41 30 63 04  
Fax: (33) 1 41 30 61 36  
Web site: <http://www.alxion.com>

Edition November 2017 – Revision 5.01